



TECHART für die 911 Modelle. | TECHART for the 911 models.







Exterieur & Aerodynamik
Exterior & Aerodynamics

8-49



für 911 Carrera und 911 Targa
 for 911 Carrera and 911 Targa

10

für 911 Turbo und 911 Turbo S
 for 911 Turbo and 911 Turbo S

26

Lack & Kohlefaser
 Paint & Carbon Fiber

36

Technologie & Antrieb
Technology & Drive

50-63

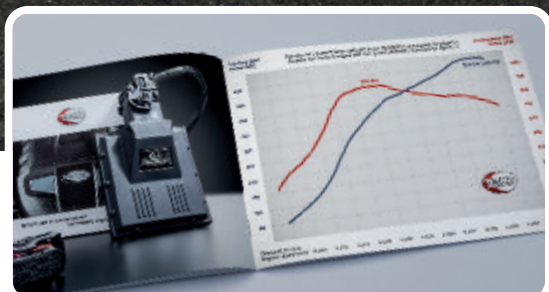

TECHTRONIC® Motormanagement
 TECHTRONIC® Engine Management

52

Leistungssteigerungen
 Engine Powerkits

54

Sport-Abgasanlagen
 Sport Exhaust Systems

60



Räder & Fahrwerk
Wheels & Chassis

64-81



Leichtmetallräder Alloy Wheels	64
Räder-Individualisierung Wheels Customization	74
Fahrwerk & TECHART Noselift® Chassis & TECHART Noselift®	76

Interieur & Komfort
Interior & Comfort

82-135



Sportlenkräder Sport Steering Wheels	84
Schalt paddles & Optionen Paddle Shifters & Options	92
Interieur Manufaktur Interior Manufactory	100

Sicherheit & Qualität

Safety & Quality

TECHART ist die internationale Premiummarke für die Individualisierung aller Porsche Modelle. Angetrieben von höchstem Designanspruch, führender technologischer Entwicklungskompetenz und verantwortungsvollem Umgang mit Emotion und Vernunft.

Grundprinzip: Erstausrüsterqualität – sichtbar und unsichtbar.

Alle originalen TECHART Produkte sind das Ergebnis dieser Maxime.

- Designentwicklung in der TECHART Modellbauabteilung sowie Optimierung aerodynamischer Komponenten im Windkanal
- CAD Konstruktion und Präzisions-Werkzeugbau für Serienfertigung im Polyurethan-RIM Spritzgussverfahren
- Prüfungen, Abgasgutachten, ABE und EG-Typgenehmigungen, E-Kennzeichen sowie z.B. R87-Zertifizierung für Tagfahrlichtsysteme
- Umfangreiche Untersuchungen zum Material- und Crashverhalten, z.B. in Materialbelastungstests und Kopfaufschlagprüfungen
- Sicherstellung hoher Lackier-, Montage- und Wartungsfreundlichkeit für den problemlosen Verbau in Porsche Zentren und Fachwerkstätten
- Komponenten- und Gesamtfahrzeugerprobung im Rennstreckeneinsatz für höchste Performance bei gleichzeitiger Alltagstauglichkeit
- Einsatz von Qualitätswerkstoffen wie PU-RIM, Kohlefaser, hochwertigen Kunststoffen sowie wertvollen Lederzurichtungen und Edelhölzern

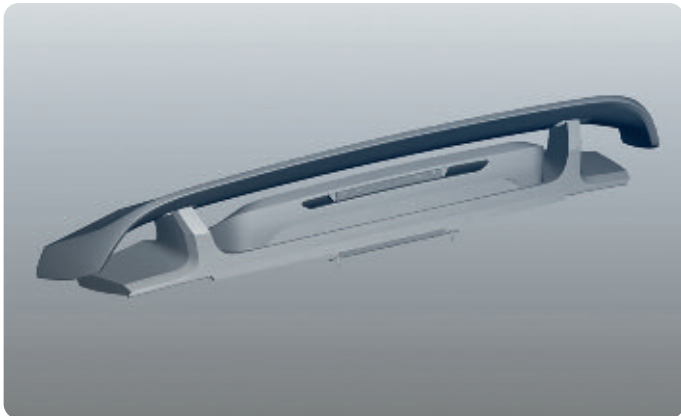

3D-Designumsetzung des Heckspoilers.
3D design processing of the rear spoiler.

TECHART is the international premium brand for individualization of any Porsche model. Driven by the highest demands on design excellence, high technology development competence and our responsible attitude towards emotion and reason.

Our core principle: OE-manufacturer quality – visible and invisible.

All genuine TECHART products are the result of this maxim.

- product design in the TECHART modelbuilding department and optimization of aerodynamic components in the wind-tunnel
- computer aided design processing and high-precision tooling for Polyurethane-RIM series production
- part certification, exhaust emissions standard homologation, type- and EC-approvals, e.g. R87-certification of daytime running lights
- extensive verification of material performance and crashworthiness, e.g. in material stress testing and head impact tests
- safeguarding of trouble-free installation, finishing and servicing at the authorized service centers, e.g. Porsche Centers or TECHART dealers
- component and vehicle testing on race tracks to secure both, the highest level of performance and every day onroad use suitability
- premium quality raw materials such as PU-RIM, carbon fiber, high strength polymer, hand selected leather hides and precious woods

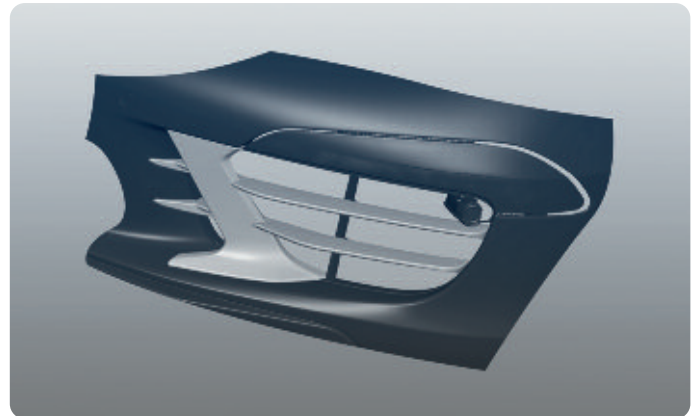

Bauteil- und Werkzeugkonstruktion erfolgt mittels CAD.
Computer aided part construction and toolmaking.

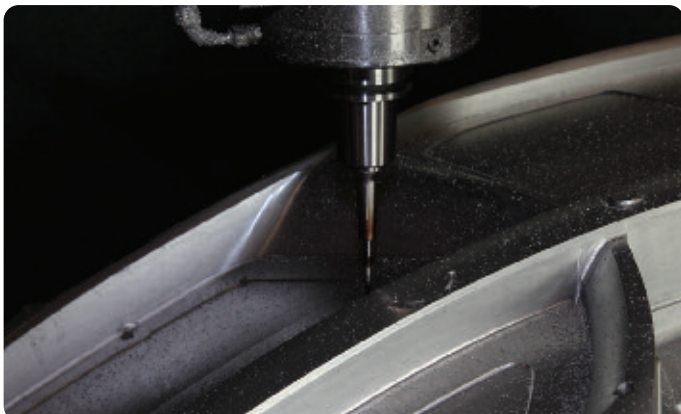

Präzisionsherstellung von PU-RIM Spritzgusswerkzeugen für Qualitäts-Serienfertigung.
High-precision injection mold tooling enables quality volume production in PU-RIM.



Crashverhalten und Fußgängerschutz: Kopfaufschlagtest einer TECHART Motorhaube.
Crashworthiness and pedestrian protection: head impact test of a TECHART engine hood.



Aerodynamikentwicklung und Bauteilkonstruktion mittels Modellbau und CAD.
Aerodynamic development and design engineering by modelbuilding and CAD.

Exterieur & Aerodynamik

Exterior & Aerodynamics



Idealzustand per Definition. »Ideal« bedeutet im technologischen Sinne die Konzentration auf das Wesentliche. In der Kunst bezeichnet es Ästhetik und Schönheit. Und ganz allgemein steht es für nicht weniger als das Streben nach Vollkommenheit.

Die TECHART Aerodynamikpakete unterstreichen den sportlichen Charakter der Individualisierung und heben das Fahrzeug gegenüber Serienmodellen sichtbar ab. Dennoch erhalten sie mit dem richtigen Maß an Zurückhaltung die unverkennbare 911 Linienführung.

Die Frontspoiler-Varianten fügen sich nahtlos in die Bugschürze ein. Je nach Modell verleihen z.B. aufrecht in die vorderen Lufteinlässe integrierte Aero Wings eine neue und dynamische Schachtkontur.

Klares Statement. Der TECHART Heckflügel. Für jedes 911 Modell in passender Ausführung, je nach technischer und optischer Anforderung. Allen gemeinsam: ausgewogene Aerodynamik in allen Geschwindigkeitsbereichen. Ein Dachspoiler, Seitenschweller und Heckdiffusoren runden das TECHART AeroKit für den Porsche 911 ab.

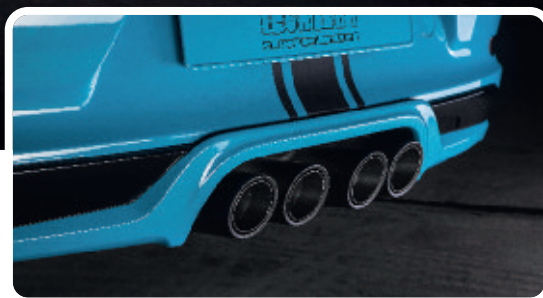
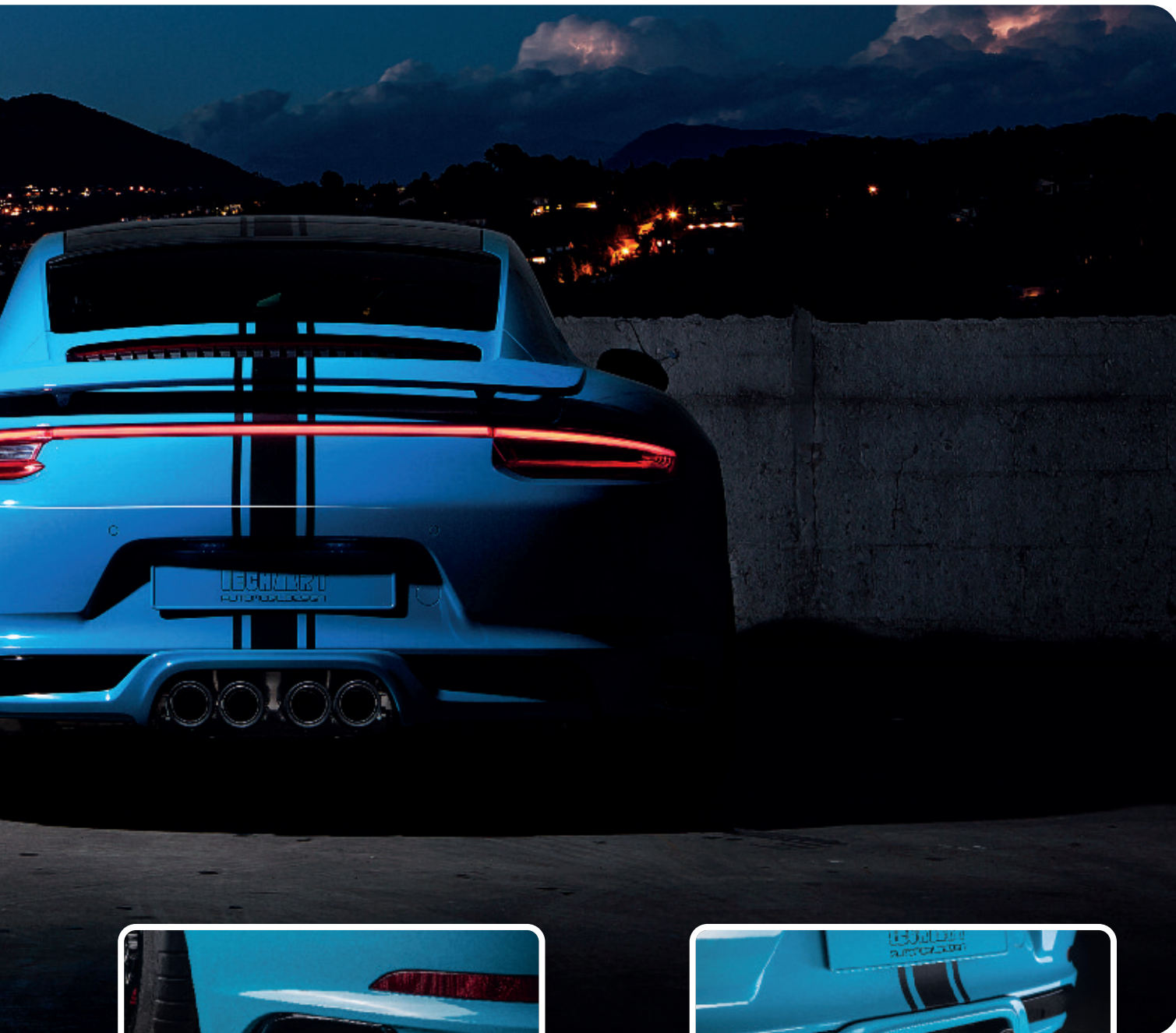

Ideal by definition. In the sense of technology, the ideal is understood as the focus on the essential. In the arts, it is the execution of esthetics and beauty. And generally speaking, the ideal is nothing less than the quest for perfection.

TECHART Aerodynamic Bodykits underline the sport-focused attitude of individualized 911 models from every angle. Typically TECHART, its subtle distinction is unmistakable. At the same time, it decently maintains the inimitable Porsche 911 design line.

All front spoiler variants merge perfectly with the surrounding shape of the 911's front apron. Depending on the specific model, features like an integral splitter and upright Aerowings in the front air intakes set additional race highlights and apply a new dynamic twin-duct design.

Clear statements: the rear wings. All TECHART rear wings are designed for the respective requirements, both in terms of technical capability and styling, ensuring well-balanced aerodynamics at all speeds. Roof spoilers, side skirts and diffusers make the TECHART Aerokits complete.

Styling für 911 Carrera und Targa

Body Styling for 911 Carrera and Targa









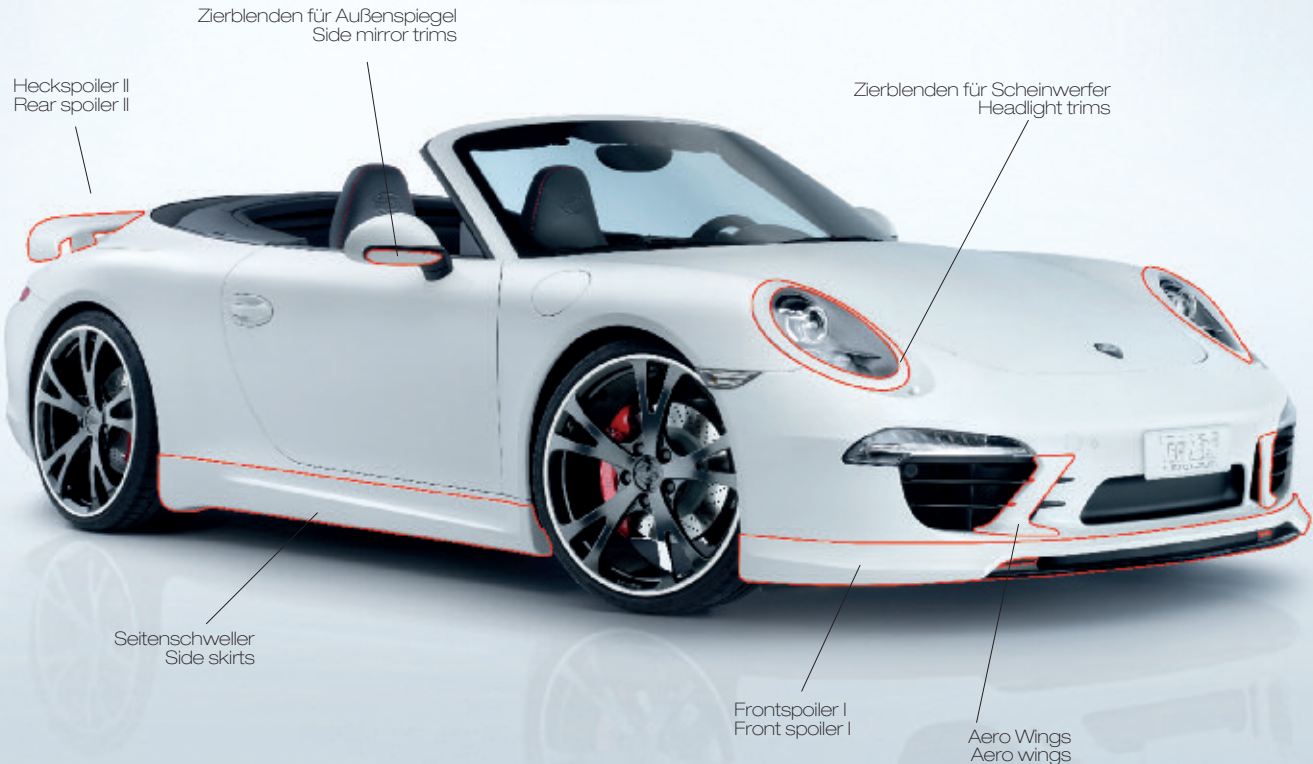



TECHART für die 911 GTS Modelle: mit Sportpaket Carbon und Formula IV Race Zentralverschlussrädern.



TECHART for the 911 GTS models: with Carbon Sport Package and Formula IV Race centerlock wheels.





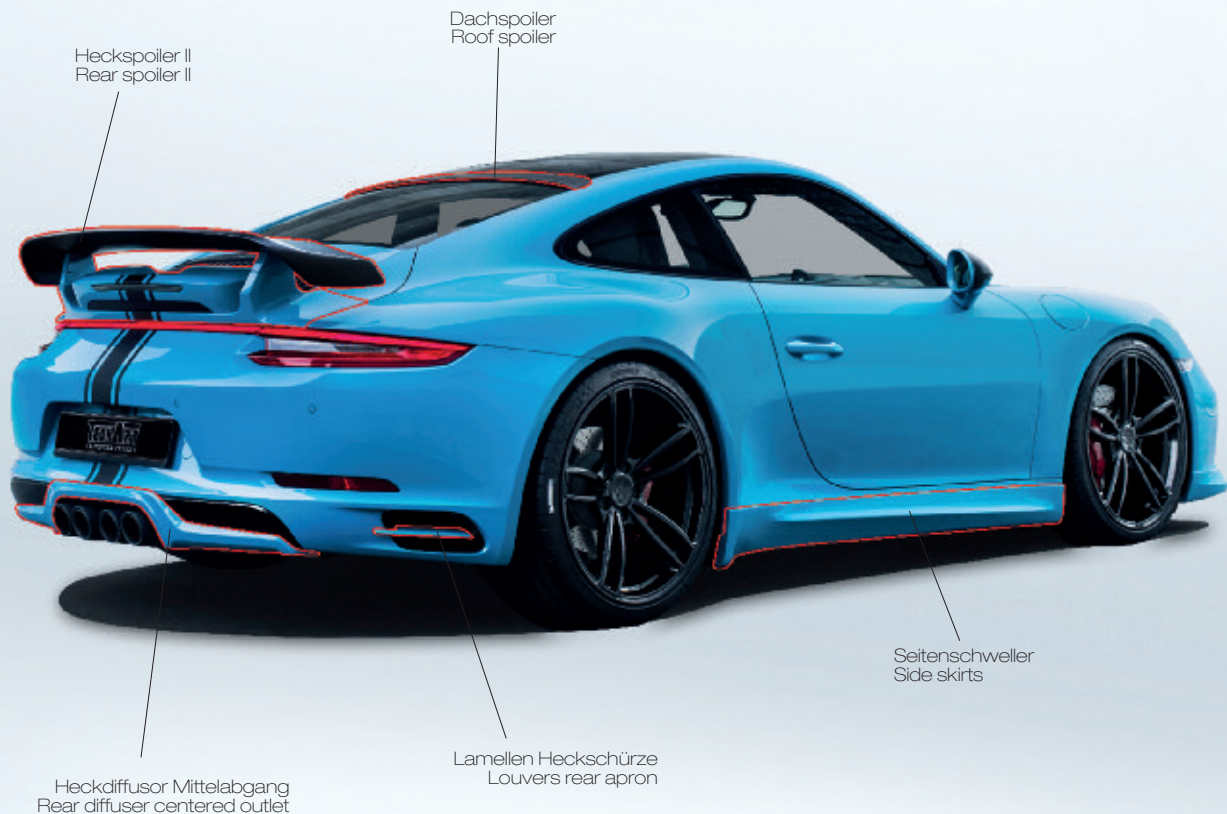



- 991/I bis Modelljahr 2016 ■ 991/I up to MY 2016
- 991/II ab Modelljahr 2017 □ 991/II as of MY 2017
- beide 991 Generationen ● both 991 generations

- 911 Carrera / Carrera Cabriolet
- 911 Carrera S / Carrera S Cabriolet
- 911 Carrera 4 / Carrera 4 Cabriolet
- 911 Carrera 4S / Carrera 4S Cabriolet
- 911 Targa 4 / Targa 4S
- 911 GTS / 4 GTS / Targa 4 GTS
- 911 GT3 / GT3 RS
- 911 Turbo / Turbo Cabriolet
- 911 Turbo S / Turbo S Cabriolet

Heckdiffusor PU-RIM für Mittelabgang	Rear diffuser PU-RIM for centered outlet	091.100.500.009 091.100.502.009 091.100.512.009	■	■	■	■	■	■			
			□	□	□	□	□	□			
			□	□	□	□	□	□			
Heckspoiler I PU-RIM Version mit erhöhten Füßen	Rear spoiler I PU-RIM version with long bases	091.100.800.009 +91.100.800.009	●	●	●	●	●	●			
			●	●	●	●	●	●			
Heckspoiler II PU-RIM	Rear spoiler II PU-RIM	091.100.810.009-02 091.100.812.009	1	1	1	1	1	1			
			1	1	1	1	1	1			
¹ Die Montage des Heckspoilerprofils ist in zwei unterschiedlichen aerodynamischen Niveaulagen möglich. Hohe Niveaulage nur bei Coupé sowie nur in Verbindung mit Frontspoiler I 091.100.100.009 oder 091.100.101.009, bzw. 091.100.102.009.	¹ The rear wing profile can be installed on two different aerodynamic height levels. High level is only applicable for Coupés and only in combination with Front Spoiler I 091.100.100.009 or 091.100.101.009 or 091.100.102.009.										
Heckverkleidung »GT-Look« PU-RIM	»GT-Look« rear apron PU-RIM	091.100.530.009			■	■	■	■			
Dachspoiler in PU-RIM ² nur für Coupé	Roof spoiler in PU-RIM ² only for Coupé	091.100.600.009	2	2	2	2	2	2	2	2	2
			2	2	2	2	2	2	2	2	2
Lamellen Heckschürze in PU	Louvers rear apron in PU	091.100.552.009	□	□	□	□	□	□			
			□	□	□	□	□	□			





»GT-Look« bestehend aus TECHART AeroKit kombiniert mit Porsche Originalteile-Heckschürze und TECHART Mittelabgang-Abgasanlage.



»GT-Look«: TECHART Aerokit in combination with a Porsche rear valance (OE part) and the TECHART Sport exhaust for centered outlet.



TECHART für die Porsche 911 Targa Modelle. Geschlossenes Dach – offenes Fahrgefühl.



TECHART for the Porsche 911 Targa models. Closed roof – open driving pleasure.

Styling für die 911 Turbo Modelle.

Body Styling for the 911 Turbo models.





■ 991/I bis Modelljahr 2016	■ 991/I up to MY 2016
□ 991/II ab Modelljahr 2017	□ 991/II as of MY 2017
● beide 991 Generationen	● both 991 generations

- 911 Carrera / Carrera Cabriolet
- 911 Carrera S / Carrera S Cabriolet
- 911 Carrera 4 / Carrera 4 Cabriolet
- 911 Carrera 4S / Carrera 4S Cabriolet
- 911 Targa 4 / Targa 4S
- 911 GTS / 4 GTS / Targa 4 GTS
- 911 GTS / GTS RS
- 911 Turbo / Turbo Cabriolet
- 911 Turbo S / Turbo S Cabriolet

Frontspoiler I PU-RIM	Front spoiler I PU-RIM	091.100.180.009-01																					
Aero Wings PU-RIM, inkl. Zierstege	Aero Wings PU-RIM, incl. trim bars	091.100.183.009 091.100.186.009																			■	■	
Heckdiffusor PU-RIM	Rear diffuser PU-RIM	091.100.580.009 091.100.582.009																			■	■	
Heckspoiler II PU-RIM	Rear spoiler II PU-RIM	091.100.881.009-03																			●	●	
¹ nur in Verbindung mit Frontspoiler I 091.100.180.009 bzw. 091.100.180.009-1		¹ only in combination with front spoiler I 091.100.180.009 or 091.100.180.009-1																					
Zierblenden für Scheinwerfer inkl. Zierblenden für Scheinwerferreinigungsanlage PU-RIM	Headlight trims incl. trims for headlight cleaning system PU-RIM	091.100.200.009	●	●	●	●	●	●	●	●	●	●	●	●	●	●	●	●	●	●	●	●	

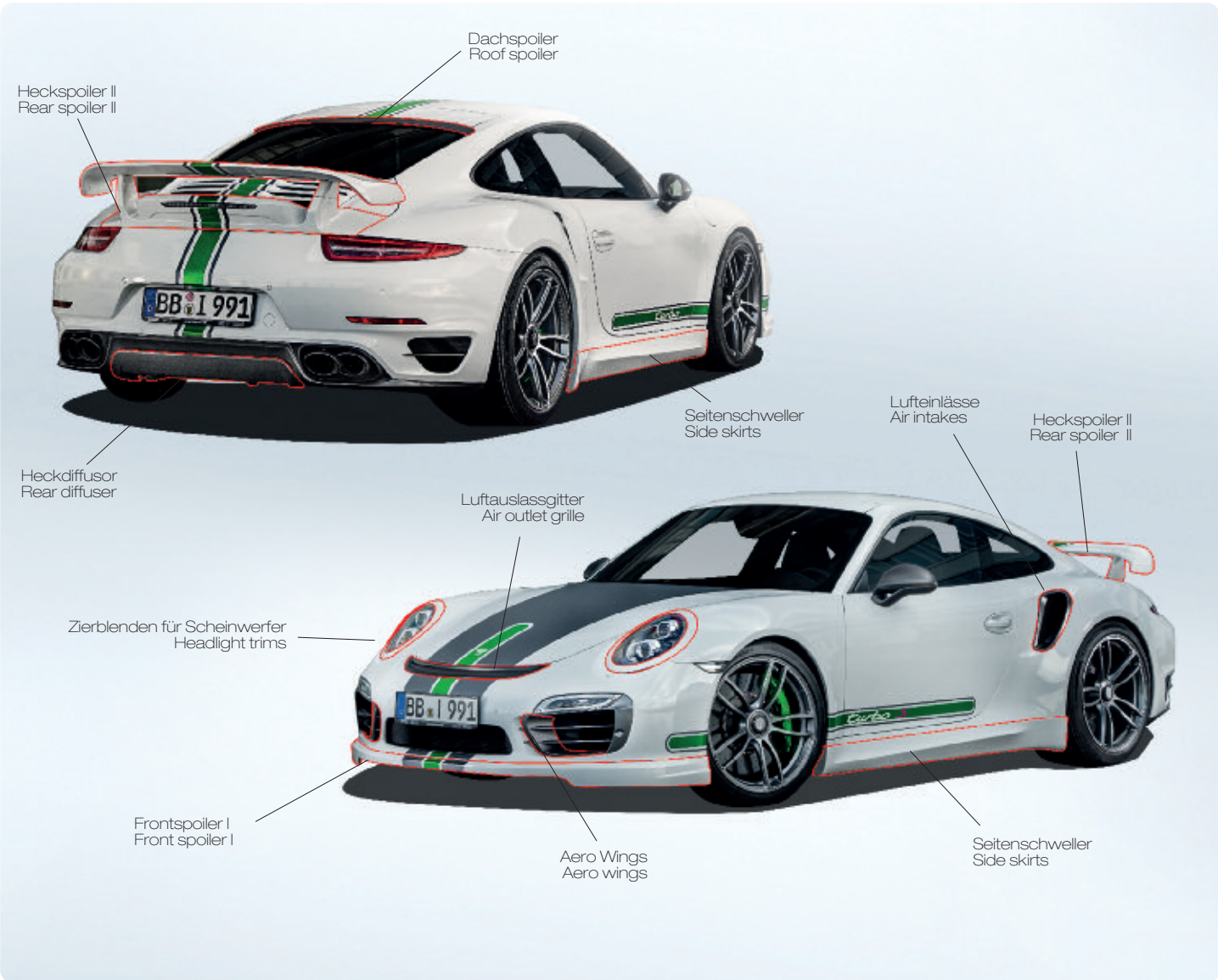

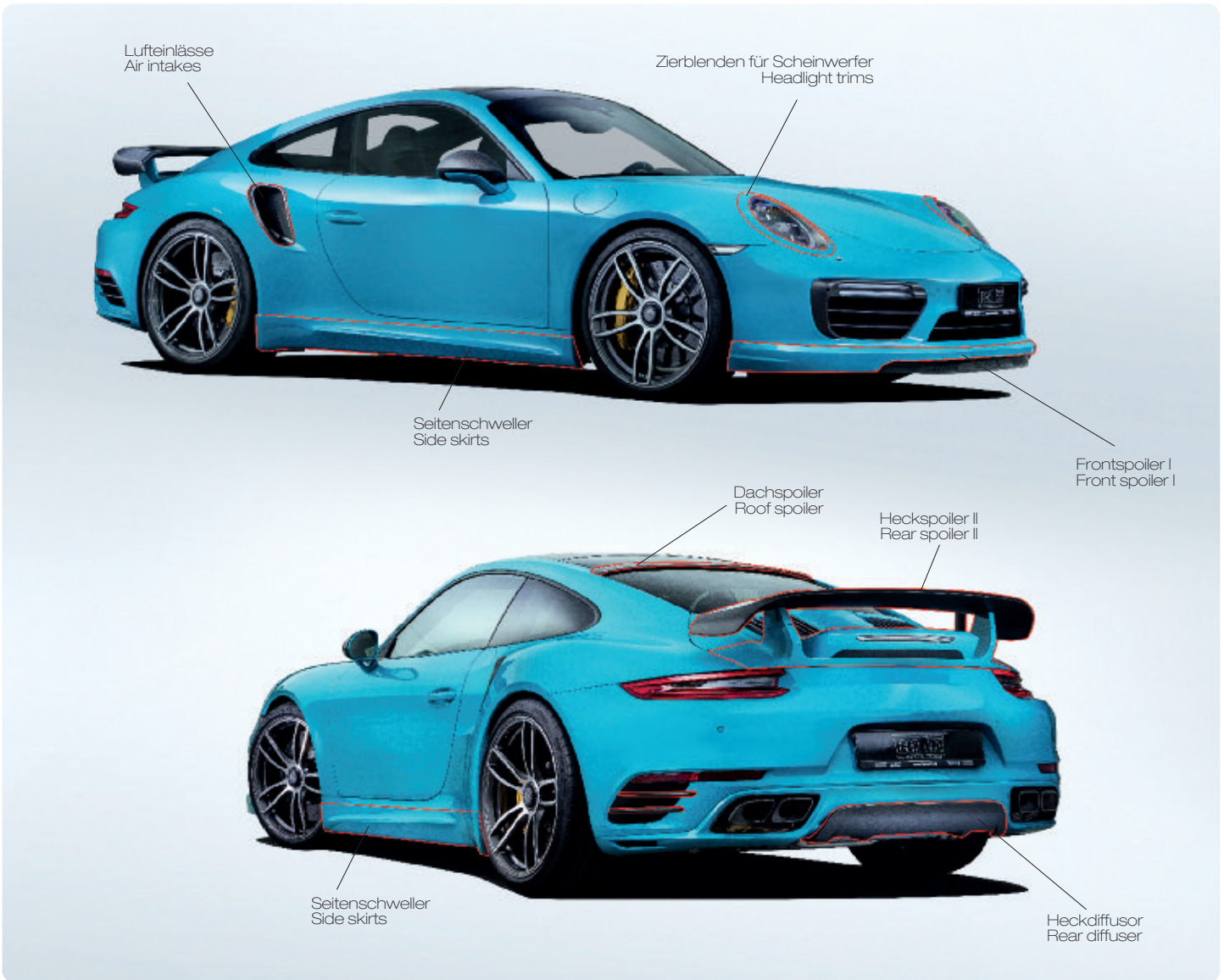

- | | |
|-----------------------------|------------------------|
| ■ 991/I bis Modelljahr 2016 | ■ 991/I up to MY 2016 |
| □ 991/II ab Modelljahr 2017 | □ 991/II as of MY 2017 |
| ● beide 991 Generationen | ● both 991 generations |

			911 Carrera / Carrera Cabriolet	911 Carrera S / Carrera S Cabriolet	911 Carrera 4 / Carrera 4 Cabriolet	911 Carrera 4S / Carrera 4S Cabriolet	911 Targa 4 / Targa 4S	911 GTS / 4 GTS / Targa 4 GTS	911 GT3 / GT3 RS	911 Turbo / Turbo Cabriolet	911 Turbo S / Turbo S Cabriolet
Seitenschweller PU-RIM <small>¹ gilt nur für GT3 ² gilt nur für GT3RS</small>	Side skirts PU-RIM <small>¹ only for GT3 ² only for GT3RS</small>	091.100.340.009 091.100.350.009 091.100.355.009	●	●	●	●	●	●	1	●	●
Luftauslassgitter an der Frontverkleidung	Air outlet grille at the front apron	091.100.182.009	●	●	●	●	●	●		●	●
Dachspoiler in PU-RIM <small>² nur für Coupé</small>	Roof spoiler in PU-RIM <small>² only for Coupé</small>	091.100.600.009	2	2	2	2		2	2	2	2
Lufteinlässe seitlich <small>siehe Kapitel »Lack & Kohlefaser« ab Seite 36 ² gilt nur für GT3RS</small>	Side air intakes <small>see chapter »Paint & Carbon Fiber« starting on page 36 ² only for GT3RS</small>								2	●	●



TECHART Aerodynamik Kit I für Porsche 991 Turbo mit Formula VI Race Rädern.



TECHART Aerodynamic kit I for Porsche 991 Turbo with Formula VI Race wheels.



GT Street R

■ 991/I bis Modelljahr 2016	■ 991/I up to MY 2016
□ 991/II ab Modelljahr 2017	□ 991/II as of MY 2017
● beide 991 Generationen	● both 991 generations

911 Carrera / Carrera Cabriolet
 911 Carrera S / Carrera S Cabriolet
 911 Carrera 4 / Carrera 4 Cabriolet
 911 Carrera 4S / Carrera 4S Cabriolet
 911 Targa 4 / Targa 4S
 911 GTS / 4 GTS / Targa 4 GTS
 911 GT3 / GT3 RS
 911 Turbo / Turbo Cabriolet
 911 Turbo S / Turbo S Cabriolet

Aerodynamik Paket »GTstreet R«

Carbon Frontverkleidung mit integrierten Luftführungen zur Be- und Entlüftung der Wasserkühler sowie der Bremsanlage an der Vorderachse
 Sichtcarbon Frontspoiler mit integrierter geschwindigkeitsabhängig aktiv gesteuerter Spoilereinheit
 Carbon Aerodynamik-Fronthaube in Individualfarbe oder Sichtcarbon
 Carbon Kotflügel vorn mit integrierten Abluftkanälen und Lamellen in Sichtcarbon
 Carbon Radhausverbreiterungen vorn und hinten in Individualfarbe oder Sichtcarbon, Sichtcarbon Schwellerverkleidungen
 Sichtcarbon Luftkanalverkleidungen in den Seitenteilen zur optimierten Anströmung der Ladeluftkühler
 Carbon Heckverkleidung mit Sichtcarbon Heckflügeleinheit mit geschwindigkeitsabhängig aktiv verstellbarem Sichtcarbon Flügelprofil

Aerokit »GTstreet R«

Carbon front apron with integrated air ducts for cooling air ventilation and heat dissipation at water radiators and front brakes
 Front spoiler in visible carbon fiber with integrated speed-dependent active spoiler adjustment
 Aerodynamic carbon front lid in custom color or visible carbon fiber
 Carbon front fenders with integrated air outlets and louvers in visible carbon fiber
 Carbon wheel arch extensions in custom color or visible carbon fiber at front and rear
 Visible carbon fiber side skirts
 Air intakes in visible carbon fiber in the rear side sections for improved inflow to the charge air coolers
 Diffusor und integrierter Radhausentlüftung
 Carbon rear apron with diffusor in visible carbon fiber and integrated wheel arch vents
 Rear wing unit with speed-dependent active adjustable wing profile in visible carbon fiber

091.100.060.009

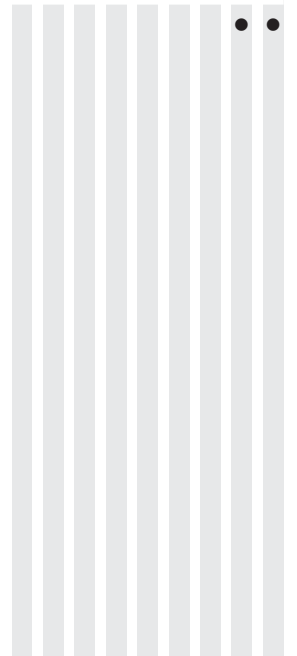

	<ul style="list-style-type: none"> ■ 991/I bis Modelljahr 2016 □ 991/II ab Modelljahr 2017 ● beide 991 Generationen 	<ul style="list-style-type: none"> ■ 991/II up to MY 2016 □ 991/II as of MY 2017 ● both 991 generations 	911 Carrera / Carrera Cabriolet	911 Carrera S / Carrera S Cabriolet	911 Carrera 4 / Carrera 4 Cabriolet	911 Carrera 4S / Carrera 4S Cabriolet	911 Targa 4 / Targa 4S	911 GTS / 4 GTS / Targa 4 GTS	911 GT3 / GT3 RS	911 Turbo / Turbo Cabriolet	911 Turbo S / Turbo S Cabriolet	
Umrüstung Leuchtenpaket und Motordeckel, Conversion of headlights and engine lid erforderlich für Coupé und Cabriolet bis MJ 2016 <small>¹ gilt nur für Coupés ² gilt nur für Cabriolets</small>	Conversion of headlights and engine lid required for Coupé and Cabriolet models up to MY 2016 <small>¹ only for Coupés ² only for Cabriolets</small>	+91.100.060.010 +91.100.060.011								● ●	● ●	
Umrüstung Heckflügelsteuerung (Wartungsstellung), erforderlich für Cabriolet ab MJ 2017	Conversion of rear wing operation (service mode), required for Cabriolet models as of MY 2017	+91.100.060.015									●	●
Lackierung Aerodynamik Paket »GTstreet R«	Paint finish Aerokit »GTstreet R«	091.108.060.998									●	●



Mehr auf techart.de/gtstreet | Learn more at techart.de/gtstreet

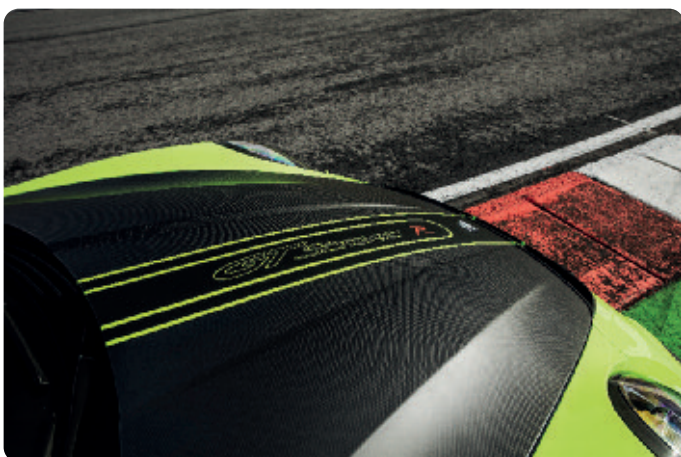



Styling und Power: der TECHART GTStreet R.



Power and Style: the TECHART GTStreet R.

Carbon für 911 GT3 MJ 2018 | Carbon for 911 GT3 MY 2018

■ 991/1 bis Modelljahr 2016	■ 991/1 up to MY 2016
□ 991/1 ab Modelljahr 2017	□ 991/1 as of MY 2017
● beide 991 Generationen	● both 991 generations

			911 Carrera / Carrera Cabriolet	911 Carrera S / Carrera S Cabriolet	911 Carrera 4 / Carrera 4 Cabriolet	911 Carrera 4S / Carrera 4S Cabriolet	911 Targa 4 / Targa 4S	911 GT3 / 4 GT3 / Targa 4 GT3	911 GT3 / GT3 RS	911 Turbo / Turbo Cabriolet	911 Turbo S / Turbo S Cabriolet
Frontspoiler in Kohlefaser glänzend in Kohlefaser matt	Front spoiler in carbon fiber, glossy finish in carbon fiber, matt finish	091.121.171.009G 091.121.171.009							1 1		
Aerohaube in Kohlefaser glänzend in Kohlefaser matt	Aero hood in carbon fiber, glossy finish in carbon fiber, matt finish	091.121.199.009G 091.121.199.009							1 1		
Airblades in Kohlefaser glänzend in Kohlefaser matt	Airblades in carbon fiber, glossy finish in carbon fiber, matt finish	091.121.179.009G 091.121.179.009							1 1		
Seitenschweller in Kohlefaser glänzend in Kohlefaser matt	Side skirts in carbon fiber, glossy finish in carbon fiber, matt finish	091.121.355.009G 091.121.355.009							1 1		
Heckspoilerblenden in Kohlefaser glänzend in Kohlefaser matt	Rear spoiler trims in carbon fiber, glossy finish in carbon fiber, matt finish	091.121.871.009G 091.121.871.009							1 1		
Heckspoilerprofil in Kohlefaser glänzend in Kohlefaser matt	Rear spoiler profile in carbon fiber, glossy finish in carbon fiber, matt finish	091.121.872.009G 091.121.872.009							1 1		
Diffusorrahmen in Kohlefaser glänzend in Kohlefaser matt	Diffuser frame in carbon fiber, glossy finish in carbon fiber, matt finish	091.121.571.009G 091.121.571.009							1 1		
Dachspoiler in Kohlefaser glänzend in Kohlefaser matt	Roof spoiler in carbon fiber, glossy finish in carbon fiber, matt finish	091.121.601.009G 091.121.601.009							1 1		
Blenden Lufthutzen in Kohlefaser glänzend in Kohlefaser matt	Air intakes covers in carbon fiber, glossy finish in carbon fiber, matt finish	091.121.771.009G 091.121.771.009							1 1		
SportDesign Spiegel in Kohlefaser Individualfarbe (6-teilig) in Kohlefaser glänzend (6-teilig) in Kohlefaser matt (6-teilig) in Individualfarbe (6-teilig)	SportDesign mirror in carbon fiber, custom color (6 pieces) in carbon fiber, glossy finish (6 pieces) in carbon fiber, matt finish (6 pieces) in custom color (6 pieces)	091.121.851.CCC 091.121.851.009G 091.121.851.009 091.108.848.998	●	●	●	●	●	●	●	●	●
Außenspiegelfüße in Kohlefaser Individualfarbe in Kohlefaser glänzend in Kohlefaser matt in Individualfarbe	Side mirror bases in carbon fiber, custom color in carbon fiber, glossy finish in carbon fiber, matt finish in custom color	091.121.845.CCC 091.121.845.009G 091.121.845.009 091.108.845.998	●	●	●	●	●	●	●	●	●
Außenspiegelschalen in Kohlefaser Individualfarbe in Kohlefaser glänzend in Kohlefaser matt	Side mirror shells in carbon fiber, custom color in carbon fiber, glossy finish in carbon fiber, matt finish	091.121.849.CCC 091.121.849.009G 091.121.849.009	●	●	●	●	●	●	●	●	●
Außenspiegelrahmen in Kohlefaser matt	Side mirror frame in carbon fiber, matt finish	091.100.850.009	●	●	●	●	●	●	●	●	●

¹ nur für 911 GT3.

¹ only for 911 GT3.



Sport pur. TECHART Kohlefaser für den 911 GT3.
Pure sports. TECHART carbon fiber for the 911 GT3.







Carbon für 911 GT3 RS | Carbon for 911 GT3 RS

■ 991/1 bis Modelljahr 2016	■ 991/1 up to MY 2016
□ 991/1 ab Modelljahr 2017	□ 991/1 as of MY 2017
● beide 991 Generationen	● both 991 generations

			911 Carrera / Carrera Cabriolet	911 Carrera S / Carrera S Cabriolet	911 Carrera 4 / Carrera 4 Cabriolet	911 Carrera 4S / Carrera 4S Cabriolet	911 Targa 4 / Targa 4S	911 GT3 / 4 GT3 / Targa 4 GT3	911 GT3 / GT3 RS	911 Turbo / Turbo Cabriolet	911 Turbo S / Turbo S Cabriolet
Frontspoiler in Kohlefaser Individualfarbe in Kohlefaser glänzend in Kohlefaser matt	Front spoiler in carbon fiber, custom color in carbon fiber, glossy finish in carbon fiber, matt finish	091.121.190.CCC 091.121.190.009G 091.121.190.009							1		
Lamellen Luftauslass Blenden in Kohlefaser Individualfarbe in Kohlefaser glänzend in Kohlefaser matt	Air outlet panels in carbon fiber, custom color in carbon fiber, glossy finish in carbon fiber, matt finish	091.121.270.CCC 091.121.270.009G 091.121.270.009							1		
Lufteinlässe seitlich in Kohlefaser Individualfarbe in Kohlefaser glänzend in Kohlefaser matt in Individualfarbe	Side air intakes in carbon fiber, custom color in carbon fiber, glossy finish in carbon fiber, matt finish in custom color	091.121.480.CCC 091.121.480.009G 091.121.480.009 091.108.481.998							1	●	●
¹ nur für 911 GT3 RS.	¹ only for 911 GT3 RS.								1	●	●
Seitenschweller in Kohlefaser Individualfarbe in Kohlefaser glänzend in Kohlefaser matt	Side skirts in carbon fiber, custom color in carbon fiber, glossy finish in carbon fiber, matt finish	091.121.355.CCC 091.121.355.009G 091.121.355.009							1		
Heckspoilerblenden in Kohlefaser Individualfarbe in Kohlefaser glänzend in Kohlefaser matt	Rear spoiler trims in carbon fiber, custom color in carbon fiber, glossy finish in carbon fiber, matt finish	091.121.890.CCC 091.121.890.009G 091.121.890.009							1		
Diffusor in Kohlefaser Individualfarbe in Kohlefaser glänzend in Kohlefaser matt	Diffuser in carbon fiber, custom color in carbon fiber, glossy finish in carbon fiber, matt finish	091.121.590.CCC 091.121.590.009G 091.121.590.009							1		
SportDesign Spiegel in Kohlefaser Individualfarbe (6-teilig) in Kohlefaser glänzend (6-teilig) in Kohlefaser matt (6-teilig) in Individualfarbe (6-teilig)	SportDesign mirror in carbon fiber, custom color (6 pieces) in carbon fiber, glossy finish (6 pieces) in carbon fiber, matt finish (6 pieces) in custom color (6 pieces)	091.121.851.CCC 091.121.851.009G 091.121.851.009 091.108.848.998	●	●	●	●	●	●	●	●	●
Außenspiegelfüße in Kohlefaser Individualfarbe in Kohlefaser glänzend in Kohlefaser matt in Individualfarbe	Side mirror bases in carbon fiber, custom color in carbon fiber, glossy finish in carbon fiber, matt finish in custom color	091.121.845.CCC 091.121.845.009G 091.121.845.009 091.108.845.998	●	●	●	●	●	●	●	●	●
Außenspiegelschalen in Kohlefaser Individualfarbe in Kohlefaser glänzend in Kohlefaser matt	Side mirror shells in carbon fiber, custom color in carbon fiber, glossy finish in carbon fiber, matt finish	091.121.849.CCC 091.121.849.009G 091.121.849.009	●	●	●	●	●	●	●	●	●
Außenspiegelrahmen in Kohlefaser matt	Side mirror frame in carbon fiber, matt finish	091.100.850.009	●	●	●	●	●	●	●	●	●
Dachspoiler in Kohlefaser Individualfarbe in Kohlefaser glänzend in Kohlefaser matt in Individualfarbe	Roof spoiler in carbon fiber, custom color in carbon fiber, glossy finish in carbon fiber, matt finish in custom color	091.121.600.CCC 091.121.600.009G 091.121.600.009 091.108.600.998	●	●	●	●	●	●	●	●	●

¹ nur für 911 GT3 RS.¹ only for 911 GT3 RS.



Sport pur. TECHART Kohlefaser für den 911 GT3 RS. Zum Beispiel das Carbon Paket in matt für die vorderen Radhausentlüftungen.
Pure sports. TECHART carbon fiber for the 911 GT3 RS. Such as the matt finished Carbon Package for the front wheel arch air outlets.





Heckschürze mit Lamellen in Carbon.
Rear apron louver in carbon fiber.



Lufteinlass in glänzender Kohlefaser.
Air intake in glossy carbon fiber.





Heckschürze mit Lamelle in Carbon.
Rear apron louver in carbon fiber.

Komplett in Kohlefaser: Airblades, Aero Wings und Zierstege Lufteinlassgitter in Carbon.
All-carbon: Airblades, Aero Wings and air intake trim bars in carbon fiber.





911 Turbo S mit TECHART Aerokit I, Exterior Sportpaket Carbon und 20-Zoll Formula IV Race Zentralverschlussrädern.
911 Turbo S with TECHART Aerokit I, Carbon Exterior Sport Package and 20-inch Formula IV Race centerlock wheels.





Technologie & Antrieb

Technology & Drive

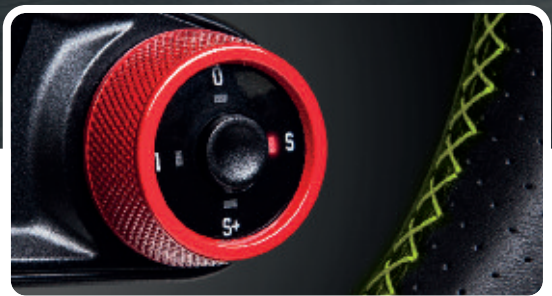
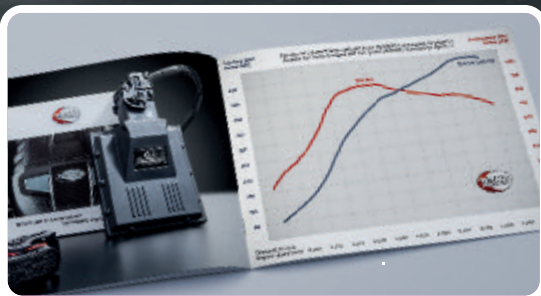

Atemberaubendes Design und leistungsfähige Technologie sind untrennbare Bestandteile aller TECHART Programme. Die technischen Optionen für Ihr Porsche 911 Modell lassen Ihnen alle Freiheiten zur Individualität und bieten Ihnen die Sicherheit geprüfter TECHART Markenqualität.

Zum Beispiel die TECHART Leistungskits mit TECHTRONIC®. Mehr Fahrspaß auf Knopfdruck durch ein spürbares Leistungsplus. Aber auch unsere Powerkits sind so vernünftig, wie Sie es von original TECHART erwarten dürfen – inklusive umfassender Garantie auf Motor und Getriebe.

Weitere Technologieumfänge für Ihr 911 Modell werden Ihr Herz höher schlagen lassen: zum Beispiel die Sportabgasanlagen für hörbare Kraftentfaltung, auch mit stufenloser Klappensteuerung. Dazu Endrohre im TECHART Doppeloval-Design oder als runde Carbon-Titan Variante.

Leichtmetallräder in fünf dynamischen Designs und unterschiedlichen Fertigungstechnologien. Fahrwerk-Upgrades für Performance und Optik mit Sportfedern und Spurverbreiterungen. Und für noch mehr Alltagstauglichkeit: das bewährte TECHART Noselift® Vorderachs-Liftsystem für zusätzliche Bodenfreiheit auf Tastendruck.

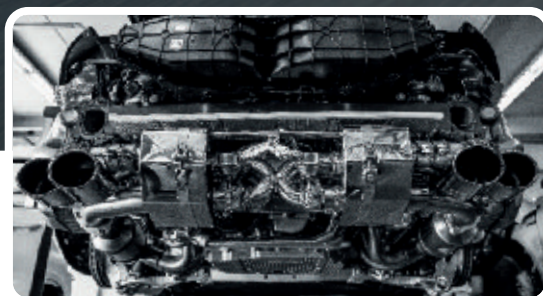

Breathtaking design and powerful technology are core values of all genuine TECHART programs. The performance options for your Porsche 911 model let you enjoy the freedom of individuality and offer you the comforting security of tested and certified TECHART premium brand quality.

Such as the TECHART engine powerkits with TECHTRONIC®. At the push of your Sport button, the output of your engine is boosted to deliver an impressive amount of power and torque. Just as sporty as you wish. And as reasonable as you may expect it from TECHART. Therefore, our powerkits include a TECHART warranty on engine and transmission.

And there's much more to make your heart rush. The TECHART performance options for your Porsche 911 include sport exhaust systems for powerful audible feedback. If you like, dynamically valve-controlled. Hallmarked by elegant stainless steel sport tailpipes in TECHART's typical twin oval design or by four central carbon titanium exhaust pipes.

TECHART wheels in five sport-driven design lines. Chassis upgrades such as sport springs and spacers, complying with performance and styling preferences. And for everyday use suitability: the renowned TECHART Noselift® front axle lift system for more ground clearance at the push of a button.



Leistungssteigerungen

Engine Powerkits

TECHART stattet Ihr 911 Modell mit bemerkenswerten Leistungsreserven aus. Atemberaubendes Design und leistungsfähige Technologie sind untrennbare Bestandteile aller TECHART Programme. Die technischen Optionen für die Porsche 911 Modelle bieten auch hier zusätzliche Freiheiten und garantieren gleichzeitig die Sicherheit geprüfter TECHART Markenqualität.

Die TECHART TECHTRONIC Leistungssteigerung für den 911 Turbo S (991/II) verwandelt serienmäßige 580 PS in 720 PS. Das Drehmoment steigt von max. 750 Nm auf kraftvolle 920 Nm. 0-100 km/h: 2,7 Sekunden¹. Höchstgeschwindigkeit: 338 km/h.

¹ unter TECHART Testbedingungen (u.a. Fahrzeug mit zwei Personen besetzt, voller Kraftstofftank). In Fahrversuchen der Presse wurden üblicherweise Werte von 2,5 Sekunden erzielt.

Die Bedienung ist intuitiv. Die Aktivierung erfolgt durch Betätigung des Fahrmodusschalters am Lenkrad. Im normalen Fahrmodus ist Sie inaktiv und das Fahrzeug wird mit serienmäßiger Motorleistung und unveränderter Kennfeldcharakteristik bewegt. Im SPORT und SPORT PLUS Modus sorgt TECHART TECHTRONIC für deutlich gesteigerte Fahrleistungen und - bei verbauter TECHART Sportabgasanlage - spektakulären Sound.

- deutliche Verbesserung von Beschleunigung und Fahrdynamik
- automatische Aktivierung im SPORT Modus
- intelligente Steuerungselektronik
- höchste Materialqualität und Erfüllung von OEM-Spezifikationen
- Fahrzeug bleibt vollständig service- und diagnosefähig
- sämtliche elektronischen Motorschutzfunktionen bleiben erhalten

TECHTRONIC Motor Management

Herzstück der Leistungssteigerung: das intelligente TECHART Motor Managementsystem TECHTRONIC. Die Installation erfolgt innerhalb kurzer Zeit durch jeden autorisierten Fachbetrieb oder TECHART Vertriebspartner. Ohne Eingriff in die serienmäßige Steuerungssoftware und ohne Beeinträchtigung der Service- und Diagnosefähigkeit.

TECHART Garantie auf Motor und Getriebe

Zusätzlich zur zweijährigen Mängelgewährleistung für alle neuen TECHART Produkte gewährt TECHART eine Garantie auf Mängel an Motor und Getriebe entsprechend der Garantiebedingungen für TECHART TECHTRONIC Leistungssteigerungen.

TECHART provides impressive power gains for your 911 model.

Breathtaking design and sophisticated technology are an inherent part of all TECHART programs. TECHART performance options set the new 911 models apart from the series models. - As always, backed by the TECHART TECHTRONIC warranty and the security of genuine TECHART OE quality.

The TECHART TECHTRONIC Powerkit for the 911 Turbo S (991/II) provides a power gain of 140 hp which makes a total of 720 hp and 920 Nm (series: 580 hp, 750 Nm). In other words: 0-100 km/h in just 2.7 seconds¹. Top track speed: 338 km/h.

¹ TECHART test specification (e.g. vehicle occupied with two passengers, fuel tank completely filled). Independent press tests typically result in 2.5 seconds.

The operation of TECHTRONIC powerkits is intuitive. To activate the permanent power boost, the driver simply switches from NORMAL to SPORT or SPORT PLUS mode by using the standard Sport Button at the center console or the standard Mode Selector at the steering wheel. While in NORMAL mode, the TECHART TECHTRONIC is inactive and the vehicle is operating with its standard power and its standard driving characteristics.

- significant increase of performance and driving dynamics
- automatic activation in SPORT mode
- intelligent electronic power management
- highest material quality and fulfillment of OEM specifications
- does not affect vehicle diagnostics or servicing
- does not affect electronic engine protection features

TECHTRONIC Engine Management

The core of the powerkit: the intelligent TECHART Engine Management System TECHTRONIC. The installation is easy and quick and can be done by every certified specialist or authorized TECHART sales partner. Without touching the standard engine management software and without affecting vehicle diagnostics or servicing.

TECHART warranty covers engine and gearbox

In addition to the two-year limited warranty all new TECHART products are backed with, TECHART grants an additional warranty on damages at engine or gearbox according to the warranty terms for TECHART TECHTRONIC engine powerkits.



Perfekte Integration. Leistungssteigerung und Klappensteuerung per Tastendruck.
Perfect integration. Power boost and exhaust valve control, both at the press of a button.



TECHART Leistungskit mit TECHTRONIC Motormanagement.
TECHART Powerkit with TECHTRONIC Engine Management.



991/I bis Modelljahr 2016

991/I up to MY 2016

TA 091/T1

- | | |
|-----------------------------|------------------------|
| ■ 991/I bis Modelljahr 2016 | ■ 991/I up to MY 2016 |
| □ 991/II ab Modelljahr 2017 | □ 991/II as of MY 2017 |
| ● beide 991 Generationen | ● both 991 generations |

911 Carrera / Carrera Cabriolet
 911 Carrera S / Carrera S Cabriolet
 911 Carrera 4 / Carrera 4 Cabriolet
 911 Carrera 4S / Carrera 4S Cabriolet
 911 Targa 4 / Targa 4S
 911 GTS / 4 GTS / Targa 4 GTS
 911 GT3 / GT3 RS
 911 Turbo / Turbo Cabriolet
 911 Turbo S / Turbo S Cabriolet

TECHART Leistungskit TA 091/T1

Mehrleistung ca. 44 kW (60 PS)
 Drehmomentzuwachs ca. 130 Nm
 Basis: 3,8l Porsche 911 Turbo Motor,
 383 kW (520 PS), 660 Nm (Overboost 710 Nm)

bestehend aus:
 TECHART- Techtronic
 Einbauhalterung
 Kabelbaum
 inkl. TÜV Gutachten

TECHART Powerkit TA 091/T1

Power increase approx. 44 kW (60 hp)
 torque increase approx. 130 Nm
 based on 3.8l Porsche 911 Turbo engine,
 383 kW (520 hp), 660 Nm (Overboost 710 Nm)

consisting of:
 TECHART TECHTRONIC
 mounting bracket
 wiring harness
 incl. TÜV Certificates

091.300.580.009

Technische Daten | Technical Data

Leistung power output	427 kW (580 PS) 427 kW (580 hp)
max. Drehmoment max. torque	840 Nm 840 Nm/620 lb.-ft.
Beschleunigung acceleration 0-100 km/h	2,9 s 2.9 s
Höchstgeschwindigkeit top speed	325 km/h 202 mph

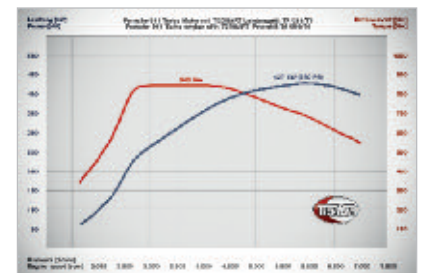

TA 091/T1.1

TECHART Leistungskit TA 091/T1.1

Mehrleistung ca. 44 kW (60 PS)
 Drehmomentzuwachs ca. 130 Nm
 Basis: 3,8l Porsche 911 Turbo S Motor,
 412 kW (560 PS), 700 Nm (Overboost 750 Nm)

bestehend aus:
 TECHART- Techtronic
 Einbauhalterung
 Kabelbaum
 inkl. TÜV Gutachten

TECHART Powerkit TA 091/T1.1

Power increase approx. 44 kW (60 hp)
 torque increase approx. 130 Nm
 based on 3.8l Porsche 911 Turbo S engine,
 412 kW (560 hp), 700 Nm (Overboost 750 Nm)

consisting of:
 TECHART TECHTRONIC
 mounting bracket
 wiring harness
 incl. TÜV Certificates

091.300.620.009

Technische Daten | Technical Data

Leistung power output	456 kW (620 PS) 456 kW (620 hp)
max. Drehmoment max. torque	880 Nm 880 Nm/649 lb.-ft.
Beschleunigung acceleration 0-100 km/h	2,8 s 2.8 s
Höchstgeschwindigkeit top speed	328 km/h 204 mph

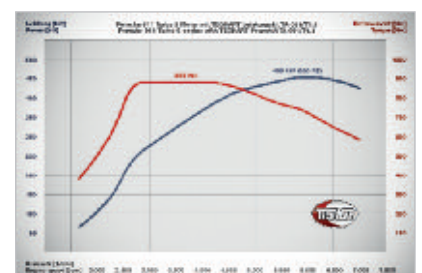



Für hörbares Fahrvergnügen: die TECHART Sportabgasanlage mit Klappensteuerung.

Die TECHART Abgasanlage »Sport« mit Klappensteuerung verabreicht den Porsche 911 Turbo und Turbo S Modellen akustische Präsenz und Aussagekraft.

Audible driving pleasure: the valve-controlled TECHART sport exhaust system.

The TECHART Exhaust System »Sport« with valve-control generates a powerful soundscape for all Porsche 911 Turbo and Turbo S models.

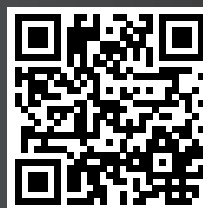

Code scannen, um das Video anzusehen.

Scan this code to watch the video.

991/II ab Modelljahr 2017

991/II as of MY 2017

TA 091/C1

- | | |
|-----------------------------|------------------------|
| ■ 991/I bis Modelljahr 2016 | ■ 991/II up to MY 2016 |
| □ 991/II ab Modelljahr 2017 | □ 991/II as of MY 2017 |
| ● beide 991 Generationen | ● both 991 generations |

911 Carrera / Carrera Cabriolet
 911 Carrera S / Carrera S Cabriolet
 911 Carrera 4 / Carrera 4 Cabriolet
 911 Carrera 4S / Carrera 4S Cabriolet
 911 Targa 4 / Targa 4S
 911 GTS / 4 GTS / Targa 4 GTS
 911 GT3 / GT3 RS
 911 Turbo / Turbo Cabriolet
 911 Turbo S / Turbo S Cabriolet

TECHART Leistungskit TA 091/C1

Mehrleistung ca. 44 kW (60 PS)
 Drehmomentzuwachs ca. 80 Nm
 Basis: 3,0l Porsche 911 Carrera Motor
 272 kW (370 PS), 450 Nm

bestehend aus:
 TECHART- Techtronic
 Einbauhalterung
 Kabelbaum
 inkl. TÜV Gutachten

¹nur für 911 Targa 4 erhältlich

TECHART Powerkit TA 091/C1

Power increase approx. 44 kW (60 hp)
 torque increase approx. 80 Nm
 based on 3.0l Porsche 911 Carrera engine,
 272 kW (370 hp), 450 Nm

consisting of:
 TECHART TECHTRONIC
 mounting bracket
 wiring harness
 incl. TÜV Certificates

¹only available for 911 Targa 4

091.300.430.009

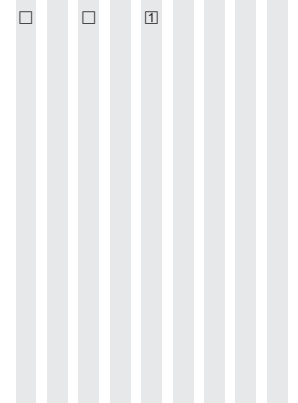

Technische Daten | Technical Data

Leistung power output	316 kW (430 PS) 316 kW (430 hp)
max. Drehmoment max. torque	530 Nm 530 Nm/391 lb.-ft.
Beschleunigung acceleration 0-100 km/h	4,5 s 4.5 s
Höchstgeschwindigkeit top speed	300 km/h 187 mph

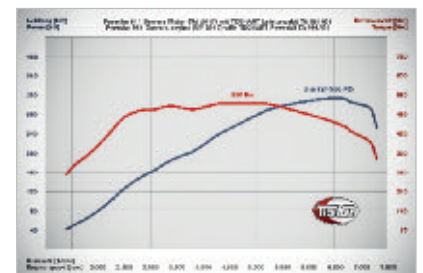

TA 091/S1

TECHART Leistungskit TA 091/S1

Mehrleistung ca. 44 kW (60 PS)
 Drehmomentzuwachs ca. 80 Nm
 Basis: 3,0l Porsche 911 Carrera S Motor,
 309 kW (420 PS), 500 Nm

bestehend aus:
 TECHART- Techtronic
 Einbauhalterung
 Kabelbaum
 inkl. TÜV Gutachten

¹nur für 911 Targa 4S erhältlich

TECHART Powerkit TA 091/S1

Power increase approx. 44 kW (60 hp)
 torque increase approx. 80 Nm
 based on 3.0l Porsche 911 Carrera S engine,
 309 kW (420 hp), 500 Nm

consisting of:
 TECHART TECHTRONIC
 mounting bracket
 wiring harness
 incl. TÜV Certificates

¹only available for 911 Targa 4S

091.300.460.009

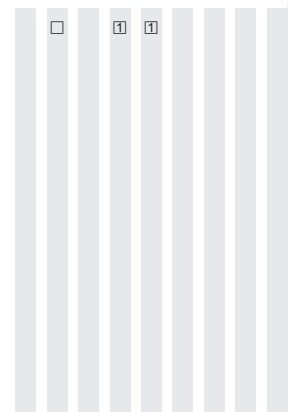

Technische Daten | Technical Data

Leistung power output	353 kW (480 PS) 353 kW (480 hp)
max. Drehmoment max. torque	580 Nm 580 Nm/428 lb.-ft.
Beschleunigung acceleration 0-100 km/h	3,7 s 3.7 s
Höchstgeschwindigkeit top speed	310 km/h 193 mph

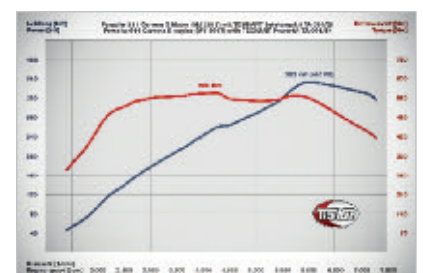

TA 091/S1.1

- | | |
|-----------------------------|------------------------|
| ■ 991/1 bis Modelljahr 2016 | ■ 991/1 up to MY 2016 |
| □ 991/1I ab Modelljahr 2017 | □ 991/1I as of MY 2017 |
| ● beide 991 Generationen | ● both 991 generations |

911 Carrera / Carrera Cabriolet
 911 Carrera S / Carrera S Cabriolet
 911 Carrera 4 / Carrera 4 Cabriolet
 911 Carrera 4S / Carrera 4S Cabriolet
 911 Targa 4 / Targa 4S
 911 GTS / 4 GTS / Targa 4 GTS
 911 GT3 / GT3 RS
 911 Turbo / Turbo Cabriolet
 911 Turbo S / Turbo S Cabriolet

TECHART Leistungskit TA 091/S1.1

Mehrleistung ca. 44 kW (60 PS)
 Drehmomentzuwachs ca. 80 Nm
 Basis: 3,0l Porsche 911 GTS Motor
 331 kW (450 PS), 550 Nm

bestehend aus:
 TECHART- Techtronic
 Einbauhalterung
 Kabelbaum
 inkl. TÜV Gutachten

¹nur für 911 Carrera GTS erhältlich

TECHART Powerkit TA 091/S1.1

Power increase approx. 44 kW (60 hp)
 torque increase approx. 80 Nm
 based on 3.0l Porsche 911 GTS engine,
 331 kW (450 hp), 550 Nm

consisting of:
 TECHART TECHTRONIC
 mounting bracket
 wiring harness
 incl. TÜV Certificates

¹only available for 911 Carrera GTS

091.300.510.009

Technische Daten | Technical Data

Leistung power output	375 kW (510 PS) 375 kW (510 hp)
max. Drehmoment max. torque	630 Nm 630 Nm/465 lb.-ft
Beschleunigung acceleration 0-100 km/h	3,4 s 3.4 s
Höchstgeschwindigkeit top speed	318 km/h 197 mph

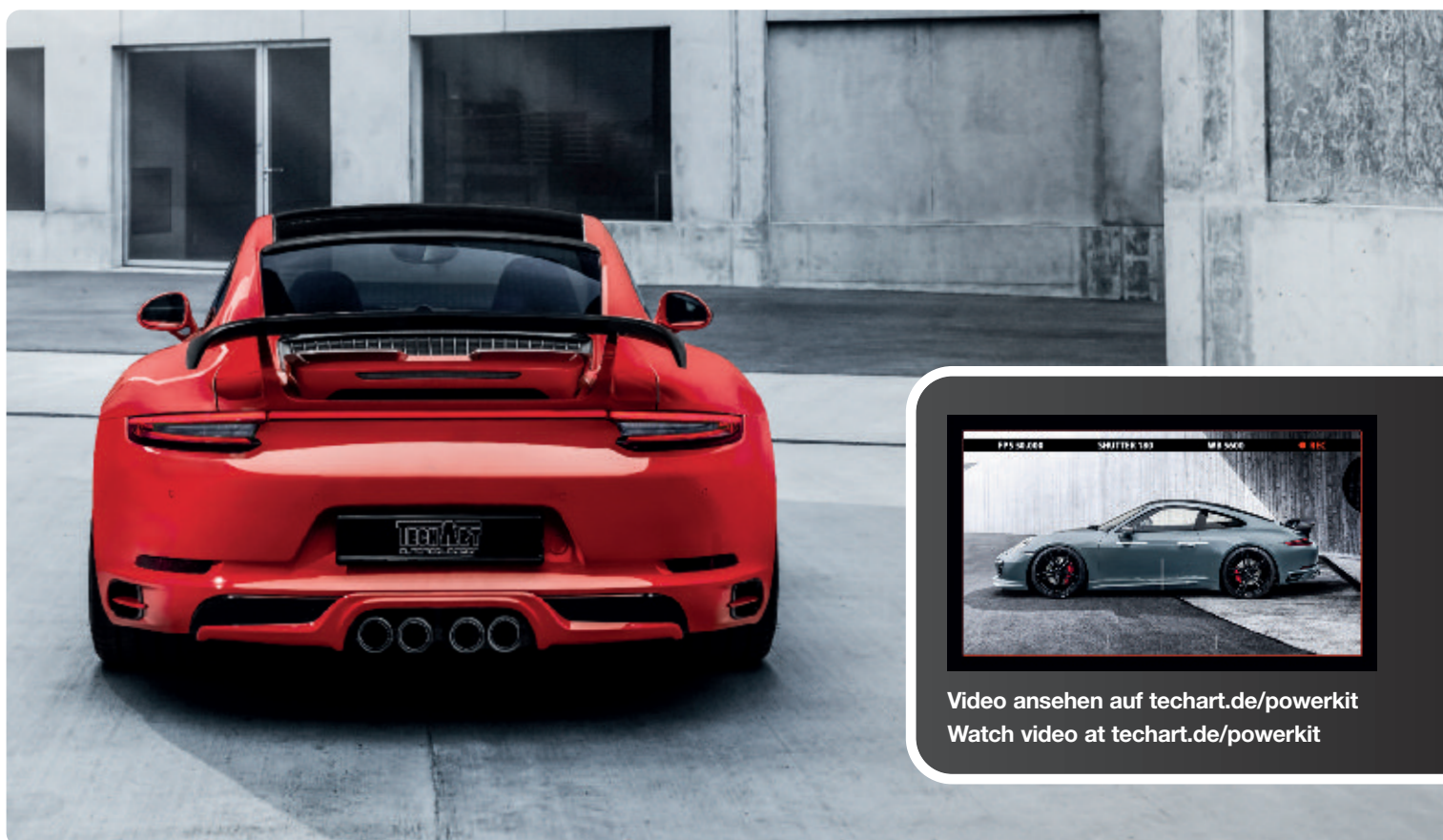
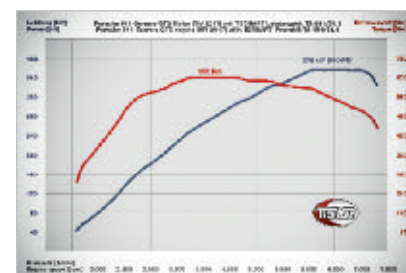

Video ansehen auf techart.de/powerkit
 Watch video at techart.de/powerkit

TA 091/T1

- 991/I bis Modelljahr 2016
- 991/II ab Modelljahr 2017
- beide 991 Generationen
- 991/I up to MY 2016
- 991/II as of MY 2017
- both 991 generations

- 911 Carrera / Carrera Cabriolet
- 911 Carrera S / Carrera S Cabriolet
- 911 Carrera 4 / Carrera 4 Cabriolet
- 911 Carrera 4S / Carrera 4S Cabriolet
- 911 Targa 4 / Targa 4S
- 911 GTS / 4 GTS / Targa 4 GTS
- 911 GT3 / GT3 RS
- 911 Turbo / Turbo Cabriolet
- 911 Turbo S / Turbo S Cabriolet

TECHART Leistungskit TA 091/T1	TECHART Powerkit TA 091/T1	091.300.600.009
Mehrleistung ca. 44 kW (60 PS) Drehmomentzuwachs ca. 130 Nm Basis: 3,8l Porsche 911 Turbo Motor, 397 kW (540 PS), 660 Nm (Overboost 710 Nm)	Power increase approx. 44 kW (60 hp) torque increase approx. 130 Nm based on 3.8l Porsche 911 Turbo engine, 397 kW (540 hp), 660 Nm (Overboost 710 Nm)	
bestehend aus: TECHART- Techtronic Einbauhalterung Kabelbaum inkl. TÜV Gutachten	consisting of: TECHART TECHTRONIC mounting bracket wiring harness incl. TÜV Certificates	

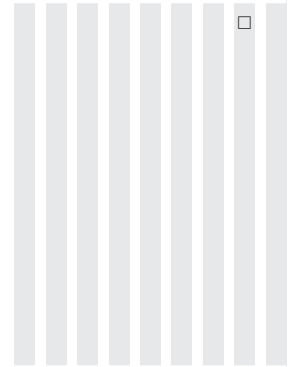

Technische Daten | Technical Data

Leistung power output	441 kW (600 PS) 441 kW (600 hp)
max. Drehmoment max. torque	840 Nm 840 Nm/620 lb.-ft.
Beschleunigung acceleration 0-100 km/h	2,8 s 2.8 s
Höchstgeschwindigkeit top speed	320 km/h 199 mph

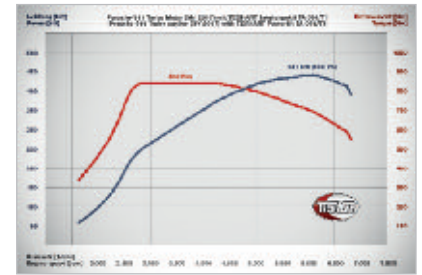

TA 091/T1.1

TECHART Leistungskit TA 091/T1.1	TECHART Powerkit TA 091/T1.1	091.300.640.009
Mehrleistung ca. 44 kW (60 PS) Drehmomentzuwachs ca. 130 Nm Basis: 3,8l Porsche 911 Turbo S Motor, 427 kW (580 PS), 700 Nm (Overboost 750 Nm)	Power increase approx. 44 kW (60 hp) torque increase approx. 130 Nm based on 3.8l Porsche 911 Turbo S engine, 427 kW (580 hp), 700 Nm (Overboost 750 Nm)	
bestehend aus: TECHART- Techtronic Einbauhalterung Kabelbaum inkl. TÜV Gutachten	consisting of: TECHART TECHTRONIC mounting bracket wiring harness incl. TÜV Certificates	

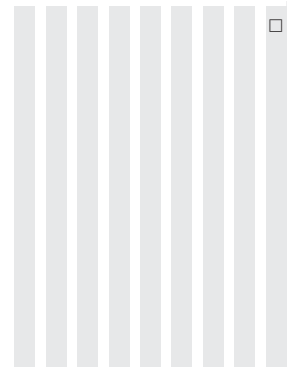

Technische Daten | Technical Data

Leistung power output	471 kW (640 PS) 471 kW (640 hp)
max. Drehmoment max. torque	880 Nm 880 Nm/649 lb.-ft.
Beschleunigung acceleration 0-100 km/h	2,7 s 2.7 s
Höchstgeschwindigkeit top speed	338 km/h 210 mph

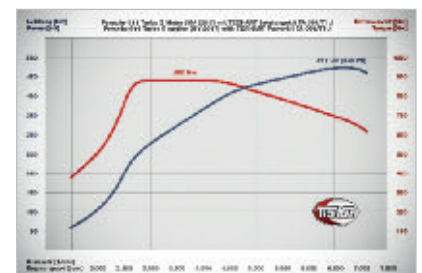

TA 091/T2

- | | |
|-----------------------------|------------------------|
| ■ 991/I bis Modelljahr 2016 | ■ 991/I up to MY 2016 |
| □ 991/II ab Modelljahr 2017 | □ 991/II as of MY 2017 |
| ● beide 991 Generationen | ● both 991 generations |

911 Carrera / Carrera Cabriolet
 911 Carrera S / Carrera S Cabriolet
 911 Carrera 4 / Carrera 4 Cabriolet
 911 Carrera 4S / Carrera 4S Cabriolet
 911 Targa 4 / Targa 4S
 911 GTS / 4 GTS / Targa 4 GTS
 911 GT3 / GT3 RS
 911 Turbo / Turbo Cabriolet
 911 Turbo S / Turbo S Cabriolet

TECHART Leistungskit TA 091/T2	TECHART Powerkit TA 091/T2	091.300.680.009
Mehrleistung ca. 103 kW (140 PS) Drehmomentzuwachs ca. 170 Nm Basis: 3,8l Porsche 911 Turbo Motor 397 kW (540 PS), 660 Nm (Overboost 710 Nm)	Power increase approx. 103 kW (140 hp) torque increase approx. 170 Nm based on 3.8l Porsche 911 Turbo engine, 397 kW (540 hp), 660 Nm (Overboost 710 Nm)	<input type="checkbox"/>
bestehend aus: TECHART- Techtronic 2 Hochleistungs-Abgasturbolader Abgasanlage TECHART "Sport" Klappengesteuert Luftansaughutze Oktanaufkleber	consisting of: TECHART TECHTRONIC 2 high performance turbo chargers exhaust system TECHART "Sport" with valve control Air intake hood Octane decal	<input type="checkbox"/>

Technische Daten | Technical Data

Leistung power output	500 kW (680 PS) 500 kW (680 hp)
max. Drehmoment max. torque	880 Nm 880 Nm/649 lb.-ft.
Beschleunigung acceleration 0-100 km/h	2,7 s 2.7 s
Höchstgeschwindigkeit top speed	320 km/h 199 mph

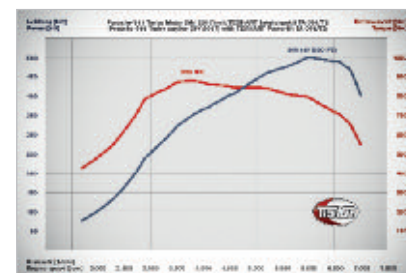

TA 091/T2.1

TECHART Leistungskit TA 091/T2.1	TECHART Powerkit TA 091/T2.1	091.300.720.009
Mehrleistung ca. 103 kW (140 PS) Drehmomentzuwachs ca. 170 Nm Basis: 3,8l Porsche 911 Turbo S Motor 427 kW (580 PS), 700 Nm (Overboost 750 Nm)	Power increase approx. 103 kW (140 hp) torque increase approx. 170 Nm based on 3.8l Porsche 911 Turbo S engine, 427 kW (580 hp), 700 Nm (Overboost 750 Nm)	<input type="checkbox"/>
bestehend aus: TECHART- Techtronic 2 Hochleistungs-Abgasturbolader Abgasanlage TECHART "Sport" Klappengesteuert Luftansaughutze Oktanaufkleber	consisting of: TECHART TECHTRONIC 2 high performance turbo chargers exhaust system TECHART "Sport" with valve control Air intake hood Octane decal	<input type="checkbox"/>

Technische Daten | Technical Data

Leistung power output	530 kW (720 PS) 530 kW (720 hp)
max. Drehmoment max. torque	920 Nm 920 Nm/679 lb.-ft.
Beschleunigung acceleration 0-100 km/h	2,7 s 2.7 s
Höchstgeschwindigkeit top speed	340 km/h 211 mph

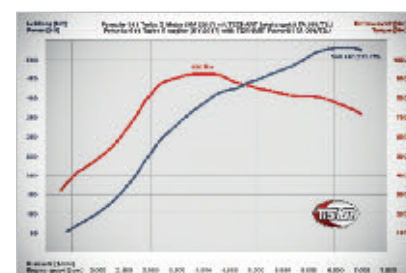



Die Mittelabgang-Sportabgasanlage »Racing« mit Diffusoreinsatz in Wagenfarbe.
The center outlet sports exhaust system »Racing« with diffuser insert in body color.



Die TECHART Mittelabgang-Sportabgasanlage »Racing« mit Klappensteuerung.
The TECHART center outlet sports exhaust system »Racing« with valve control.

Sport-Abgasanlagen

Sport Exhaust Systems

- 991/I bis Modelljahr 2016 ■ 991/I up to MY 2016
- 991/II ab Modelljahr 2017 □ 991/II as of MY 2017
- beide 991 Generationen ● both 991 generations

- 911 Carrera / Carrera Cabriolet
- 911 Carrera S / Carrera S Cabriolet
- 911 Carrera 4 / Carrera 4 Cabriolet
- 911 Carrera 4S / Carrera 4S Cabriolet
- 911 Targa 4 / Targa 4S
- 911 GTS / 4 GTS / Targa 4 GTS
- 911 GT3 / GT3 RS
- 911 Turbo / Turbo Cabriolet
- 911 Turbo S / Turbo S Cabriolet

<p>TECHART Mittelabgang-Sportabgasanlage »Racing« mit Klappensteuerung bestehend aus TECHART Schalldämpfern mit dynamischer Abgasklappenregelung und elektronischem Steuergerät, zentral angeordneten gefeilteten Endrohren sowie Diffusoreinsatz in sportlichem Design in schwarz oder Individualfarbe</p> <p>Nicht zulässig im Geltungsbereich der deutschen StVZO.</p>	<p>TECHART center outlet sports exhaust system »Racing« with valve control consisting of TECHART silencers with dynamic exhaust flap adjustment and electronic valve control unit, centrally aranged v-shaped tailpipes and a sport design diffuser insert in black or in custom color</p> <p>Does not comply with the German road traffic regulations (StVZO).</p>	<p>091.310.600.009</p>	<ul style="list-style-type: none"> ■ □ □ □ □ □ □ □ □
<p>TECHART Mittelabgang-Sportabgasanlage 4-flutig mit Klappensteuerung Nur in Verbindung mit optionaler Sportabgasanlage</p>	<p>TECHART center outlet 4-flow sports exhaust system »Racing« with valve control Only in combination with optinal sport exhaust system</p>	<p>091.310.500.009</p>	<ul style="list-style-type: none"> □ □ □ □ □ □ □ □ □
<p>TECHART Sportabgasanlage mit Klappensteuerung bestehend aus TECHART Schalldämpfer mit dynamischer Abgasklappenregelung und elektronischem Steuergerät inkl. EG-Typgenehmigung</p> <p>¹ nur in Verbindung mit TECHART Endrohren 091.310.91[...]009 sowie Ausrüstung mit Porsche Sportabgasanlage ab Werk ² nur in Verbindung mit TECHART Endrohren 091.310.91[...]009. Für Fahrzeuge ohne Porsche Sportabgasanlage ab Werk zzgl. Nachrüstung Unterdruckleitungen 091.310.200.325-01 ³ für Targa 4 siehe ■ / für Targa 4S siehe ■</p>	<p>TECHART sports exhaust system with valve control consisting of TECHART silencer with dynamic exhaust flap adjustment and electronic valve control unit incl. EC conformity certificate</p> <p>¹ only available with TECHART tailpipes 091.310.91[...]009 and Porsche factory sports exhaust system ² only available with TECHART tailpipes 091.310.91[...]009. For vehicles without Porsche factory sports exhaust system, vacuum pipes backfitting 091.310.200.325-01 is required ³ for Targa 4 see ■ / for Targa 4S see ■</p>	<p>091.310.320.009-01 091.310.650.009</p>	<ul style="list-style-type: none"> 1 2 1 2 3 ● ●

- 991/I bis Modelljahr 2016
- 991/II ab Modelljahr 2017
- beide 991 Generationen
- 991/II up to MY 2016
- 991/II as of MY 2017
- both 991 generations

911 Carrera / Carrera Cabriolet
 911 Carrera S / Carrera S Cabriolet
 911 Carrera 4 / Carrera 4 Cabriolet
 911 Carrera 4S / Carrera 4S Cabriolet
 911 Targa 4 / Targa 4S
 911 GTS / 4 GTS / Targa 4 GTS
 911 GT3 / GT3 RS
 911 Turbo / Turbo Cabriolet
 911 Turbo S / Turbo S Cabriolet

TECHART Sportschalldämpfer »Racing«	TECHART sports silencer »Racing«	091.310.300.009								
Nicht zulässig im Geltungsbereich der deutschen StVZO.	Does not comply with the German road traffic regulations (StVZO).									
⁴ nur in Verbindung mit TECHART Endrohren sowie Ausrüstung mit Porsche Sportabgasanlage ab Werk	⁴ only available with TECHART tailpipes and with Porsche factory sports exhaust system									
TECHART Sportendrohre zweiflutig oval, in Edelstahl mit geprägtem TECHART Schriftzug	TECHART sports tailpipes dual oval tube, in stainless steel with embossed TECHART logotype									
verchromt, hochglänzend schwarzverchromt, matt	high-gloss chromed black chromed, matt finish	091.310.910.009 091.310.911.009	⑥ ⑥	⑥ ⑥	⑤ ⑤	⑤ ⑤	⑤ ⑤			
verchromt, hochglänzend schwarzverchromt, matt	high-gloss chromed black chromed, matt finish	097.310.910.009 097.310.911.009	■ ■			⑥ ⑥				
verchromt, hochglänzend schwarzverchromt, matt	high-gloss chromed black chromed, matt finish	091.310.960.009 091.310.970.009							■ ■	■ ■
⁵ nur in Verbindung mit Porsche Sportabgasanlage ab Werk	⁵ only in conjunction with Porsche factory sports exhaust system									
⁶ nicht erhältlich für Targa 4S	⁶ not available for Targa 4S									
TECHART Sportendrohre Carbon	TECHART sports tailpipes Carbon									
vierflutig rund, in Carbon matt mit geprägtem TECHART Schriftzug	4-flow round tube, in Carbon fiber matt with embossed TECHART logotype	091.310.450.009		□						
zweiflutig rund, in Carbon matt mit geprägtem TECHART Schriftzug	dual round tube, in Carbon fiber matt with embossed TECHART logotype	091.310.460.009							□	



Die TECHART Sportabgasanlage 4-flutig, Endrohre in Titan/Carbon.
 The TECHART 4-flow sports exhaust system, tailpipes in titanium/carbon.



Die TECHART Endrohre in Titan/Carbon für GT3.
 The TECHART tailpipes in titanium/carbon for GT3.





TECHART Leichtmetallräder

TECHART light alloy wheels



Original TECHART Räder stehen für eigenständiges Design, das perfekt zu den Porsche 911 Modellen passt. Von TECHART entwickelt und exklusiv nach den strengen TECHART Qualitätsstandards produziert. Aus Prinzip. Allen gemeinsam: neben den attraktiven Standard-Farbvarianten ist auch die individuelle farbliche Abstimmung auf Ihr Fahrzeug möglich.

Zum Beispiel das klassische **TECHART Formula Leichtmetallrad**. Die elegante Form der Speichen bietet Raum für große Öffnungen. Für effiziente Wärmeabfuhr und einen unverbauten Blick auf die Bremsanlage Ihres 911 Modells. **TECHART Formula II**, die sportliche Evolution des TECHART Formula Designs, vereint Vorteile des Monoblockrads mit der sportlichen Note mehrteiliger Optik.

Das TECHART Formula III Schmiederad ist ein Bekenntnis zur Sportlichkeit. Das geringe Eigengewicht mit fünf dynamisch gestalteten Doppelspeichen trägt unmittelbar zur Steigerung der Fahrdynamik bei.

TECHART Formula IV Leichtmetallräder interpretieren das typische TECHART Raddesign in einer sportlichen 5-Doppelspeichen Struktur.

Als geschmiedete Variante mit Zentralverschluss steht das **TECHART Formula IV Race Technologierad** für die 911 GTS, 911 Turbo und 911 GT3 Familien bereit. Der Fertigungsprozess nutzt spezielle Schmiede- und Undercut Technologien, mit deren Hilfe ein besonders geringes Eigengewicht realisiert werden kann.

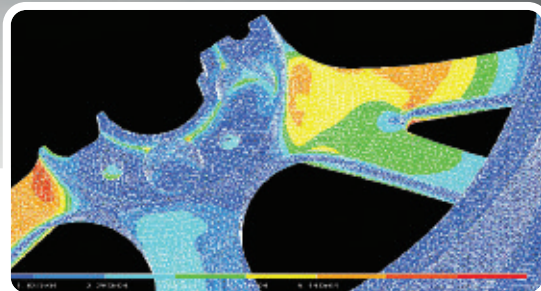

Genuine TECHART wheels are distinctive design, perfectly hallmarking your individual Porsche 911 model. Exclusive TECHART-engineered designs, manufactured at the highest TECHART quality standards. And no matter which wheel design you may choose, all TECHART wheels are also available in individually matched custom colors.

Such as the classic five-spoke **TECHART Formula wheel**. Its elegant shape incorporates large spaces between the spokes. This does not only provide a clear view of your 911's braking system but enables an efficient heat dissipation at the same time. **TECHART Formula II**, the sportive evolution of the TECHART Formula design, combines the advantages of a monoblock wheel and the sporty look of a multipart styling.

The forged TECHART Formula III is a clear statement of sportiness. The particularly low weight of the dynamic twin-spokes wheel directly results in reduced unsprung masses and enhanced driving performance.

TECHART Formula IV wheels reinterpret the renowned TECHART wheel design in a sporty five twin-spokes structure and offer another great styling option for the Porsche 911 model range.

Featuring a central locking device, its forged variant **TECHART Formula IV Race** is available for the 911 GTS, 911 Turbo and 911 GT3 families. In the production process, the use of special forging technologies and under-cut processing enables a particularly low weight.



TECHART Aerokit I und TECHART Formula III Schmiederäder.



TECHART Aerokit I and TECHART Formula III forged wheels.



20-Zoll TECHART Formula Leichtmetallrad in schwarz glänzend.
20-inch TECHART Formula light alloy wheel in gloss black.

TECHART Formula



- | | |
|-----------------------------|------------------------|
| ■ 991/I bis Modelljahr 2016 | ■ 991/I up to MY 2016 |
| □ 991/II ab Modelljahr 2017 | □ 991/II as of MY 2017 |
| ● beide 991 Generationen | ● both 991 generations |

- 911 Carrera / Carrera Cabriolet
- 911 Carrera S / Carrera S Cabriolet
- 911 Carrera 4 / Carrera 4 Cabriolet
- 911 Carrera 4S / Carrera 4S Cabriolet
- 911 Targa 4 / Targa 4S
- 911 GTS / 4 GTS / Targa 4 GTS
- 911 GT3 / GT3 RS
- 911 Turbo / Turbo Cabriolet
- 911 Turbo S / Turbo S Cabriolet

20-Zoll TECHART Formula	20-inch TECHART Formula								
5-Speichen Monoblock Leichtmetallrad	5-spoke monoblock light alloy wheel								
8,5J x 20 ET 52 Shiny Silber	8.5J x 20 OT 52 Shiny Silver	097.210.850.052	●	●	●	●	●	●	●
8,5J x 20 ET 52 GTS (schwarz glänzend)	8.5J x 20 OT 52 GTS (glossy black)	097.210.850.052GTS	●	●	●	●	●	●	●
11J x 20 ET 55 Shiny Silber	11J x 20 OT 55 Shiny Silver	097.210.110.055			●	●	●	●	●
11J x 20 ET 55 GTS (schwarz glänzend)	11J x 20 OT 55 GTS (glossy black)	097.210.110.005GTS			●	●	●	●	●
11J x 20 ET 68 Shiny Silber	11J x 20 OT 68 Shiny Silver	091.210.110.068	●	●	●	●	●	●	●
11J x 20 ET 68 GTS (schwarz glänzend)	11J x 20 OT 68 GTS (glossy black)	091.210.110.068GTS	●	●	●	●	●	●	●
Individualfarbe	custom color	064.218.210.998	●	●	●	●	●	●	●

21-Zoll TECHART Formula	21-inch TECHART Formula								
5-Speichen Monoblock Leichtmetallrad	5-spoke monoblock light alloy wheel								
9J x 21 ET 50 Shiny Silber	9J x 21 OT 50 Shiny Silver	091.210.901.050	●	●	●	●	●	●	●
9J x 21 ET 50 GTS (schwarz glänzend)	9J x 21 OT 50 GTS (glossy black)	091.210.901.050GTS	●	●	●	●	●	●	●
11J x 21 ET 63 Shiny Silber	11J x 21 OT 63 Shiny Silver	070.210.111.063	●	●	●	●	●	●	●
11J x 21 ET 63 (schwarz glänzend)	11J x 21 OT 63 GTS (glossy black)	070.210.111.063GTS	●	●	●	●	●	●	●
Individualfarbe	custom color	064.218.210.998	●	●	●	●	●	●	●

- 1. Gen. bis Modelljahr 2016 / Gen. 1 up to MY 2016
- 2. Gen. ab Modelljahr 2017 / Gen. 2 as of MY 2017
- Beide Generationen / Both Generations



20-Zoll TECHART Formula Leichtmetallrad in schwarz glänzend, Felgenrand glanzgedreht.
20-inch TECHART Formula light alloy wheel in gloss black with gloss-turned wheel edge.



21-Zoll TECHART Formula Leichtmetallrad in Shiny Silber.
21-inch TECHART Formula light alloy wheel in Shiny Silver.



20-Zoll TECHART Formula II Leichtmetallrad in Ausführung GTS.
20-inch TECHART Formula II light alloy wheel in GTS finish.



Gemeinsamkeit aller TECHART Formula II Räder: mehrteilige Optik und polierter Edelstahlring.
Feature of all TECHART Formula II wheels: multi-part styling and polished stainless steel ring.

TECHART Formula II



- | | |
|-----------------------------|------------------------|
| ■ 991/I bis Modelljahr 2016 | ■ 991/I up to MY 2016 |
| □ 991/II ab Modelljahr 2017 | □ 991/II as of MY 2017 |
| ● beide 991 Generationen | ● both 991 generations |

- 911 Carrera / Carrera Cabriolet
- 911 Carrera S / Carrera S Cabriolet
- 911 Carrera 4 / Carrera 4 Cabriolet
- 911 Carrera 4S / Carrera 4S Cabriolet
- 911 Targa 4 / Targa 4S
- 911 GTS / 4 GTS / Targa 4 GTS
- 911 GT3 / GT3 RS
- 911 Turbo / Turbo Cabriolet
- 911 Turbo S / Turbo S Cabriolet

20-Zoll TECHART Formula II

5-Speichen Monoblock Leichtmetallrad
sportliches mehrteiliges Design
8,5J x 20 ET 52 Shiny Silber
8,5J x 20 ET 52 GTS (schwarz glänzend)
11J x 20 ET 55 Shiny Silber
11J x 20 ET 55 GTS (schwarz glänzend)
Individualfarbe

22-inch TECHART Formula II

5-spoke monoblock light alloy wheel
sporty multipart design
8.5J x 20 OT 52 Shiny Silver
8.5J x 20 OT 52 GTS (glossy black)
11J x 20 OT 55 Shiny Silver
11J x 20 OT 55 GTS (glossy black)
custom color

097.212.852.052
097.212.852.052GTS
097.212.112.055
097.212.112.055GTS
064.218.210.998

911 Carrera / Carrera Cabriolet	●	●	●	●
911 Carrera S / Carrera S Cabriolet	●	●	●	●
911 Carrera 4 / Carrera 4 Cabriolet	●	●	●	●
911 Carrera 4S / Carrera 4S Cabriolet	●	●	●	●
911 Targa 4 / Targa 4S	●	●	●	●
911 GTS / 4 GTS / Targa 4 GTS	●	●	●	●
911 GT3 / GT3 RS	●	●	●	●
911 Turbo / Turbo Cabriolet	●	●	●	●
911 Turbo S / Turbo S Cabriolet	●	●	●	●

- 1. Gen. bis Modelljahr 2016 / Gen. 1 up to MY 2016
- 2. Gen. ab Modelljahr 2017 / Gen. 2 as of MY 2017
- Beide Generationen / Both Generations





21-Zoll TECHART Formula III Leichtmetallrad in Sterling Silber.
21-inch TECHART Formula III light alloy wheel in Sterling Silver.

TECHART Formula III



- | | |
|-----------------------------|------------------------|
| ■ 991/I bis Modelljahr 2016 | ■ 991/I up to MY 2016 |
| □ 991/II ab Modelljahr 2017 | □ 991/II as of MY 2017 |
| ● beide 991 Generationen | ● both 991 generations |

			911 Carrera / Carrera Cabriolet	911 Carrera S / Carrera S Cabriolet	911 Carrera 4 / Carrera 4 Cabriolet	911 Carrera 4S / Carrera 4S Cabriolet	911 Targa 4 / Targa 4S	911 GTS / 4 GTS / Targa 4 GTS	911 GT3 / GT3 RS	911 Turbo / Turbo Cabriolet	911 Turbo S / Turbo S Cabriolet
20-Zoll TECHART Formula III 5-Speichen Monoblock Leichtmetall-Schmiederad											
20-inch TECHART Formula III 5-spoke forged light alloy wheel											
8,5J x 20 ET 52 Sterling Silber	8.5J x 20 ET 52 Sterling Silver	097.215.852.052-02	●	●	●	●	●	●			
11J x 20 ET 55 Sterling Silber	11J x 20 ET 55 Sterling Silver	097.215.112.055-02	●	●	●	●	●	●			
11J x 20 ET 68 Sterling Silber	11J x 20 ET 68 Sterling Silver	091.215.110.068	●	●	●	●	●	●			
8,5J x 20 ET 52 keramikpoliert	8.5J x 20 ET 52 ceramic polished	097.215.852.052KER	●	●	●	●	●	●			
11J x 20 ET 55 keramikpoliert	11J x 20 ET 55 ceramic polished	097.215.112.055KER	●	●	●	●	●	●			
11J x 20 ET 68 keramikpoliert	11J x 20 ET 68 ceramic polished	091.215.110.068KER	●	●	●	●	●	●			
Individualfarbe, einfarbig	custom color, uni-color	097.218.215.998	●	●	●	●	●	●			
Individualfarbe, zweifarbig	custom color, bi-color	097.218.216.998	●	●	●	●	●	●			
Pulverbeschichtet schwarz	Powder-coated black	097.218.218.998	●	●	●	●	●	●			
Pulverb. schwarz, Felgenreand in Individualfarbe	Powder-coated black, outer rim in custom color	097.218.217.998	●	●	●	●	●	●			
21-Zoll TECHART Formula III 5-Speichen Monoblock Leichtmetall-Schmiederad											
21-inch TECHART Formula III 5-spoke forged light alloy wheel											
9J x 21 ET 50 Sterling Silber	9J x 21 OT 50 Sterling Silver	091.215.901.050	●	●	●	●	●	●	●	●	●
9J x 21 ET 50 Bicolor	9J x 21 OT 50 bicolor	091.215.901.050BIC	●	●	●	●	●	●	●	●	●
9J x 21 ET 50 keramikpoliert	9J x 21 OT 50 ceramic polished	091.215.901.050KER	●	●	●	●	●	●	●	●	●
11,5J x 21 ET 77 Sterling Silber	11.5J x 21 OT 77 Sterling Silver	070.215.115.177	●	●	●	●	●	●	●	●	●
11,5J x 21 ET 77 Bi-Color	11.5J x 21 OT 77 Bi-Color	070.215.115.177BIC	●	●	●	●	●	●	●	●	●
11,5J x 21 ET 77 keramikpoliert	11.5J x 21 OT 77 ceramic polished	070.215.115.177KER	●	●	●	●	●	●	●	●	●
Individualfarbe, einfarbig	custom color, uni-color	097.218.215.998	●	●	●	●	●	●	●	●	●
Individualfarbe, zweifarbig	custom color, bi-color	097.218.216.998	●	●	●	●	●	●	●	●	●
Pulverbeschichtet schwarz	Powder-coated black	097.218.218.998	●	●	●	●	●	●	●	●	●
Pulverb. schwarz, Felgenreand in Individualfarbe	Powder-coated black, outer rim in custom color	097.218.217.998	●	●	●	●	●	●	●	●	●

¹ zusätzlich benötigt: Umrüstung von Zentralverschluss auf 5-Loch Verschraubung 091.200.900.009

¹ additionally required: conversion of the central locking device into 5 hole connection 091.200.900.009



21-Zoll TECHART Formula IV.
21-inch TECHART Formula IV light alloy wheel.



21-Zoll TECHART Formula IV Leichtmetallrad.
21-inch TECHART Formula IV light alloy wheel.

TECHART Formula IV



- | | |
|-----------------------------|------------------------|
| ■ 991/I bis Modelljahr 2016 | ■ 991/I up to MY 2016 |
| □ 991/II ab Modelljahr 2017 | □ 991/II as of MY 2017 |
| ● beide 991 Generationen | ● both 991 generations |

21-Zoll TECHART Formula IV 5-Doppelspeichen Leichtmetallrad

9J x 21 ET 50 Bi-Color
11J x 21 ET 58 Bi-Color
12J x 21 ET 49 Bi-Color
12J x 21 ET 57 Bi-Color
Individualfarbe, Stirnfläche glanzpoliert

¹ zusätzlich benötigt: Umrüstung von Zentralverschluss auf 5-Loch Verschraubung 091.200.900.009

21-inch TECHART Formula IV 5-twin spokes light alloy wheel

9J x 21 OT 50 Bi-Color
11J x 21 OT 58 Bi-Color
12J x 21 OT 49 Bi-Color
12J x 21 OT 57 Bi-Color
custom color, polished front surface

¹ additionally required: conversion of the center lock device into 5 hole connection 091.200.900.009

091.214.901.050BIC
091.214.111.058BIC
091.214.121.049BIC
091.214.121.057BIC
000.218.105.22S

911 Carrera / Carrera Cabriolet	911 Carrera S / Carrera S Cabriolet	911 Carrera 4 / Carrera 4 Cabriolet	911 Carrera 4S / Carrera 4S Cabriolet	911 Targa 4 / Targa 4S / Targa 4 GTS	911 GTS / 4 GTS	911 GT3 / GT3 RS	911 Turbo / Turbo Cabriolet	911 Turbo S / Turbo S Cabriolet
●	●	●	●	●	●		●	●
●	●						●	●
●		●	●	●	●			
●		●	●	●	●		●	●
●		●	●	●	●		●	●





20-Zoll TECHART Formula IV Race Leichtmetallrad in Bi-Color.
20-inch TECHART Formula IV Race light alloy wheel in Bi-Color.



911 Turbo mit TECHART Formula IV Race Leichtmetallrad.
911 Turbo with TECHART Formula IV Race light alloy wheel.

TECHART Formula IV Race



- | | |
|-----------------------------|------------------------|
| ■ 991/I bis Modelljahr 2016 | ■ 991/I up to MY 2016 |
| □ 991/II ab Modelljahr 2017 | □ 991/II as of MY 2017 |
| ● beide 991 Generationen | ● both 991 generations |

- 911 Carrera / Carrera Cabriolet
- 911 Carrera S / Carrera S Cabriolet
- 911 Carrera 4 / Carrera 4 Cabriolet
- 911 Carrera 4S / Carrera 4S Cabriolet
- 911 Targa 4 / Targa 4S
- 911 GTS / 4 GTS / Targa 4 GTS
- 911 GTS / GTS RS
- 911 Turbo / Turbo Cabriolet
- 911 Turbo S / Turbo S Cabriolet

20-Zoll TECHART Formula IV
5-Doppelspeichen Leichtmetallrad
einteilig, mit Zentralverschluss
Titangrau, Stirnfläche glanzgedreht

9J x 20 ET 46
12J x 20 ET 47
12J x 20 ET 58

¹ je nach Fahrzeugausstattung zusätzlich benötigt: Umrüstung von 5-Loch Verschraubung auf Zentralverschluss 091.200.901.009

20-inch TECHART Formula IV
5-twin spokes light alloy wheel
one-piece, with center lock device
Titanium Grey, polished front surface

9J x 20 OT 46
12J x 20 OT 47
12J x 20 OT 58

¹ additionally required as necessary: conversion of the 5 hole connection into center lock device 091.200.901.009

091.216.902.046BIC
091.216.122.047BIC
091.216.122.058BIC

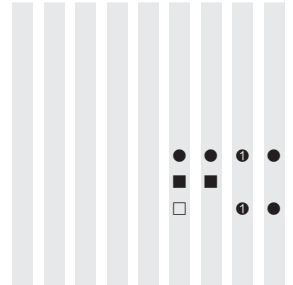

- 1. Gen. bis Modelljahr 2016 / Gen. 1 up to MY 2016
- 2. Gen. ab Modelljahr 2017 / Gen. 2 as of MY 2017
- Beide Generationen / Both Generations





TECHART Formula IV Race Schmiederad »Individual« in Titangrau matt.
TECHART Formula IV Race forged wheel »custom color« in Titanium Grey matt.



Individualfarben und -oberflächen

Custom colors and surfaces

Die individuelle Abstimmung Ihrer TECHART Räder auf Ihr Fahrzeug erfolgt genau nach Ihren Wünschen. Ton in Ton mit der Farbe der Bremssättel, abgestimmt auf die Ziernähte im Interieur, zwei- oder mehrfarbig lackiert, mit mattierter Oberfläche oder mit markant abgesetztem Felgenreand in Kontrastfarbe. Selbst die mehrfarbige Ausführung Ihrer Porsche Originalräder sind kein Problem. In anderen Worten: genau so individuell wie Sie mögen.

Wenn »perfekt« zu Ihren Lieblingsworten gehört, sind Sie hier richtig. Denn feine Details bringen Ihre Räder ideal zur Geltung. Zum Beispiel TECHART Spurverbreiterungen: sie verleihen Ihrem Fahrzeug einen noch sportlicheren Look. Die Räder schließen ausdistanziert mit den Radhauskanten ab. Ihr Fahrzeug wirkt bereits im Stillstand dynamischer.

The individual color match of your TECHART wheels offers even more opportunities to add your personal taste: color-coordinated with your brake calipers, aligned with your interior decorative stitching, bi- or multi-color painted, with a matt surface finish or with a distinctive wheel edge in contrast color. And even if you prefer to have your OE wheels individually color-matched: no problem. In other words: be just as individual as you like it.

»Perfect« is one of your favorite words? – Perfect. It's the fine details, that highlight your wheels just perfectly. Such as TECHART spacers for your Porsche. They create a wider track and add an even sportier look to your vehicle. The wheels are aligned in order to be flush with the wheel arches. Your car's presence immediately increases. Even at standstill.



■ 991/I bis Modelljahr 2016	■ 991/I up to MY 2016
□ 991/II ab Modelljahr 2017	□ 991/II as of MY 2017
● beide 991 Generationen	● both 991 generations

**Reifendruckelektronik Kit
für europäische Länder (433 MHz)**

bestehend aus

- 4 x Sensorelektronik
- 4 x Ventilausführung RDK

**Tire pressure ECU kit
for European countries (433 MHz)**

consisting of

- 4 x electronic sensor unit
- 4 x TPM valve

091.210.100.009

070.210.120.009

**Reifendruckelektronik Kit
für nichteuropäische Länder (315 MHz)**

bestehend aus

- 4 x Sensorelektronik
- 4 x Ventilausführung RDK

**Tire pressure ECU kit
for non-European countries (315 MHz)**

consisting of

- 4 x electronic sensor unit
- 4 x TPM valve

091.210.150.009

070.210.170.009

911 Carrera / Carrera Cabriolet	■	■	■	■	■	■	■	■	■
911 Carrera S / Carrera S Cabriolet	□	□	□	□	□	□	□	□	□
911 Carrera 4 / Carrera 4 Cabriolet	■	■	■	■	■	■	■	■	■
911 Carrera 4S / Carrera 4S Cabriolet	□	□	□	□	□	□	□	□	□
911 Targa 4 / Targa 4S	■	■	■	■	■	■	■	■	■
911 GTS / 4 GTS / Targa 4 GTS	□	□	□	□	□	□	□	□	□
911 GT3 / GT3 RS	■	■	■	■	■	■	■	■	■
911 Turbo / Turbo Cabriolet	□	□	□	□	□	□	□	□	□
911 Turbo S / Turbo S Cabriolet	■	■	■	■	■	■	■	■	■





Bremssattel in Individualfarbe.
Brake caliper in custom color.

Fahrwerk & Räder-Zubehör

Chassis & Wheels Accessories

- | | |
|-----------------------------|------------------------|
| ■ 991/I bis Modelljahr 2016 | ■ 991/I up to MY 2016 |
| □ 991/II ab Modelljahr 2017 | □ 991/II as of MY 2017 |
| ● beide 991 Generationen | ● both 991 generations |

			911 Carrera / Carrera Cabriolet	911 Carrera S / Carrera S Cabriolet	911 Carrera 4 / Carrera 4 Cabriolet	911 Carrera 4S / Carrera 4S Cabriolet	911 Targa 4 / Targa 4S	911 GTS / 4 GTS / Targa 4 GTS	911 GT3 / GT3 RS	911 Turbo / Turbo Cabriolet	911 Turbo S / Turbo S Cabriolet
TECHART Sportfedernsatz für Serienstoßdämpfer, Absenkung des Fahrzeugniveaus um bis zu 30 mm Tieferlegung Fahrzeuge mit Standardfahrwerk: ca. 30mm Tieferlegung Fahrzeuge mit PASM: ca. 20mm Tieferlegung Fahrzeuge mit PASM Sport: ca. 10mm	TECHART sport spring kit fits OE dampers, allows ride height lowering by up to 30 mm Lowering for vehicles with standard chassis: approx. 30mm Lowering for vehicles with PASM: approx. 20mm Lowering for vehicles with PASM Sport: approx. 10mm	091.200.120.009 091.200.200.009 091.200.140.009	■	■	■	■	■	■			
Distanzscheibensatz zur Spurverbreiterung an Vorder-/Hinterachse 2 x 7 mm 2 x 10 mm inkl. Radmuttern und TÜV Gutachten ¹ nicht erhältlich für Fahrzeuge mit Zentralverschluss	Spacer kit for wider track at front/rear 2 x 7 mm 2 x 10 mm incl. wheel nuts and TÜV certificate ¹ not available for vehicles with center lock device	096.280.007.009 000.280.010.009	●	●	●	●	●	●		●	●
Bremssättel in Individualfarbe	Custom painted calipers	000.358.200.998	●	●	●	●	●	●	●	●	●
Umrüstung Zentralverschluss Zentralverschluss auf 5-Loch Verschraubung 5-Loch Verschraubung auf Zentralverschluss	Conversion center lock central locking device to 5 hole connection 5 hole connection to center lock device	091.200.900.009 091.200.901.009								●	●



TECHART Distanzscheiben.
TECHART wheel spacers.



TECHART Spurverbreiterung mit Diebstahlsicherung.
TECHART track widening kit with anti-theft locking system.



Für sichtbar mehr Fahrdynamik: TECHART Spurverbreiterungen.
For visibly improved driving dynamics: TECHART wheel spacers.



Das TECHART Noselift System

The TECHART Noselift System

Tiefgarageneinfahrten, Rampen oder Bordsteine – das TECHART Noselift System lässt Probleme mit alltäglichen Hindernissen der Vergangenheit angehören. Auf Knopfdruck stehen am Frontspoiler je nach Fahrzeugmodell 60 bis 65 mm mehr Bodenfreiheit durch Anhebung des Fahrzeugniveaus an der Vorderachse zur Verfügung.

Das hydraulische TECHART Noselift System überzeugt durch TECHART-typische Alltagstauglichkeit, höchste Zuverlässigkeit und problemlose Nachrüstung.

- Betätigung bei Fahrzeugstillstand sowie während der Fahrt
- automatische Absenkung oberhalb 60 km/h
- schnelle Niveauperstellung
- vollintegriert Bedienung per Taste mit Statusanzeige
- besonders leises Betriebsgeräusch
- keine Einschränkung des Kofferraumvolumens durch kompakte Bauweise der Hydraulikeinheit
- inklusive Teilegutachten

Das TECHART Grundprinzip: Erstausrüsterqualität. Neben einer perfekten Integration ins Fahrzeug sind Prüfungen der elektromagnetischen Verträglichkeit der Steuergeräte, die Entwicklung fahrzeugspezifischer Kabelsätze mit CAN-Datenbusanbindung sowie auf höchste Belastungen ausgelegte Prüfzyklen Teil der Produktentwicklung.

Ramps, speed humps and curbs – the TECHART Noselift system makes such common obstacles being a thing of the past. Depending on the respective model, 60 – 65 mm of additional ground clearance at the front spoiler are provided at the push of a button through hydraulic ride-height control at the front axle in order to prevent grounding.

Like all TECHART products, the hydraulic TECHART Noselift system features typical TECHART usability, highest technical reliability as well as trouble-free backfitting.

- operation at standstill or while driving
- automatic lowering at over 37 mph
- rapid height adjustment
- fully integrated operation via button with status indicator
- particularly silent during operation
- no reduction of luggage space thanks to the compact design of the hydraulic unit
- certification included

TECHART's basic principle: OE-quality in every detail. Besides perfect vehicle integration, EMC-safe electronic control units, vehicle-specific CAN bus integrated wiring harnesses as well as high-performance test procedures are part of the premium development process.



Perfekte Integration: TECHART Noselift Bedienschalte im Ablagefach der Mittelkonsole.
Perfect integration: TECHART Noselift button in the center console storage compartment.



Sport, durch und durch: TECHART für die 911 GTS Modelle.



Sport, through and through: TECHART for the 911 GTS models.

Interieur & Komfort

Interior & Comfort



Nichts ist so kostbar wie Ihre Unabhängigkeit. Sollten Sie nicht auch bei Ihrem Porsche 911 Modell selbst bestimmen können, wie Sie Ihre Inneneinrichtung gestalten?

Außergewöhnliche Qualität und Sorgfalt zeichnen seit jeher echte TECHART Interieurs aus. Porsche Besitzer in aller Welt schätzen die präzise handwerkliche Verarbeitung wertvoller Werkstoffe durch die TECHART Manufaktur. Das gilt ebenso für die Auswahl der Materialien, die Abstimmung der Farben und das Gespür für Ästhetik. Jeder dieser Schritte richtet sich ganz nach Ihrer individuellen Vorstellung.

Ob Sie sich für feine Akzente entscheiden oder für die Fertigung eines bis ins Detail einzigartigen Interieurs, bis hin zur Fertigung eines exklusiven Unikats in wunderbar geschmeidigem Naturleder – TECHART setzt der Verwirklichung Ihrer Vorstellung von Individualität keine Grenzen.

Auf Wunsch beraten Sie die erfahrenen TECHART Sattlermeister persönlich in der hauseigenen Manufaktur und begleiten Sie bei der Planung Ihres individuellen Fahrzeuginterieurs für Ihr Porsche 911 Modell. So kommen Sie Schritt für Schritt der Umsetzung Ihrer ganz persönlichen Vorstellungen näher.



There is nothing as precious as your independence. Why should you let someone else decide how to furnish your personal interior of your Porsche 911 model?

TECHART handcrafted interiors are world-renowned for their extraordinary level of quality and accuracy. This applies to the careful choice of select materials, the tasteful orchestration of colors as well as our sense of design and the unmatched precision and craftsmanship of the TECHART leathershop. You will be able to feel this diligence and effort immediately. As it is our very aim to turn your individual vision into reality.

You might prefer to set some selective highlights. Or you might entrust us to create your unique interior according to your personal perception and taste. Such as a uniquely designed TECHART interior, created of supple, natural leather. If you like, its design can incorporate colors, materials or symbols that play an important role in your life.

The master craftsmen of the TECHART in-house saddlery are at your service, willing to share their years of experience to give personal advice. TECHART sets no limits to what is possible in order to create your individual interior as a personal piece of art.

TECHART Sportlenkräder

TECHART Sport Steering Wheels

TECHART Sportlenkräder und von TECHART veredelte oder restaurierte Porsche Lenkräder sind Individualität pur: feinste Materialien, perfekte Ergonomie und hervorragende handwerkliche Verarbeitung. Die Fertigung echter TECHART Lenkräder erfordert in jedem Arbeitsschritt außergewöhnliche Qualität und Präzision. Deshalb erfolgt die Herstellung ausschließlich in der TECHART Interieurmanufaktur in Leonberg.

Auf Grundlage des Kranz-Skeletts des Originallenkrades entsteht zunächst der TECHART-typische ergonomisch geformte Basis-Lenkradkranz. Der hierzu eingesetzte Schaumkunststoff muss besondere Anforderungen erfüllen. Denn er dient neben der eigentlichen Formgebung dazu, Aufprallenergie im Falle eines Crashes durch Verformung aufzunehmen. Die Umkleidung erfolgt in einem Gussverfahren mit Hilfe eigens konstruierter Formwerkzeuge. Spätere Individualisierungsschritte wie die Kombination unterschiedlicher Materialien oder die Montage von TECHART Schaltpaddles werden bereits hier mit eingeformten Haltestrukturen vorbereitet.

Der weitere Schichtaufbau bestimmt Durchmesser und Haptik des Lenkradkranzes. Hierbei werden sogenannte Abstandsgewirke verwendet, die sich besonders durch Druckentlastung, Thermoregulation, Luftdurchlässigkeit und ihr definiertes elastisches Verhalten in Längs- und Querrichtung auszeichnen. Die Airbageinheit des Originallenkrades komplettiert das Lenkrad. Die Abdeckung des Pralltopfes wird passend zum übrigen Lenkrad gefertigt und trägt das TECHART Emblem.

Für das sichtbare Äußere steht das gesamte Repertoire der TECHART Sattlermeister zur Verfügung. Beispielsweise weiches Leder, wertvolle Holzfurniere, Alcantara®, Kohlefaser, Lackoberflächen oder das Strukturleder TECHART CarboBLACK®. Auf Wunsch in perforierter Ausführung, mit 12-Uhr Markierung, Ziernähten und Biesen. Perfekt auf das individuelle Interieur abgestimmt, bis hin zu Detailarbeiten wie Griffbereichen mit farbig hinterlegter Perforation.

Das Beziehen und Vernähen findet vollständig in Handarbeit statt. Die vier wichtigsten Arbeitsmittel: Rundnadel, Garn, Ruhe und Sorgfalt. Und selbst wenn Sie sich nicht für ein individuelles TECHART Lenkrad entscheiden: mit der gleichen Sorgfalt und einer großen Auswahl an Materialien und Farben veredelt TECHART auch Ihr Originallenkrad oder restauriert das Lenkrad Ihres Youngtimers. Wenn Sie es wünschen, beraten Sie die erfahrenen TECHART Sattlermeister gerne persönlich.

TECHART steering wheels as well as TECHART refined and refurbished Porsche steering wheels are pure individuality composed by select materials, perfect design and outstanding craftsmanship. Every stage of production requires an extraordinary level of quality and accuracy. This is why all genuine TECHART steering wheels are handmade at the TECHART leathershop in Leonberg/Germany.

Invisible technology: the raw steel structure of the original steering wheel is the basis on which the typically shaped TECHART steering wheel is built. The sheathing of the wheel rim is done in a casting process using proprietary molding tools. Now already, the following individualization steps play an important role, as the molds are specific depending on whether different cover materials will be combined and if paddle shifters will be fitted. The caoutchouc-like rubber-foam compound which is used has to fulfill specific safety requirements as the material does not only give the shape to the wheel but it is designed to absorb impact energy through defined deforming in the case of a crash.

Diameter and feel are determined by the layer composition. So-called spacer fabrics are used, which also feature important material properties such as pressure discharge, thermoregulation, air permeability and defined elastic behavior.

The rich repertoire of the master craftsmen of the TECHART saddlery turns all this into a piece of art made of finest materials. Such as supple leather, precious wood veneers, Alcantara®, carbon fiber, lacquer, or the textured leather TECHART CarboBLACK®. If desired, perforated, featuring a customized straight-ahed marker, decorative stitchings and leather pipings. In other words: a perfect composition to match the individual interior design of your Porsche.

All upholstery and sewing is done by hand. The most important tools: a curved needle, quality yarn, calmness and care. The steering wheel is completed by the original airbag unit, which becomes individually refined according to the chosen steering wheel design and which is finally hall-marked by the TECHART emblem. Good to know: even if you do not choose an individual TECHART steering wheel for your Porsche, TECHART refines and refurbishes your original Porsche steering wheel, too. Feel free to select among the wide variety of colors and materials. Do not hesitate to contact us. If desired our master craftsmen themselves will be happy to act as your advisor.

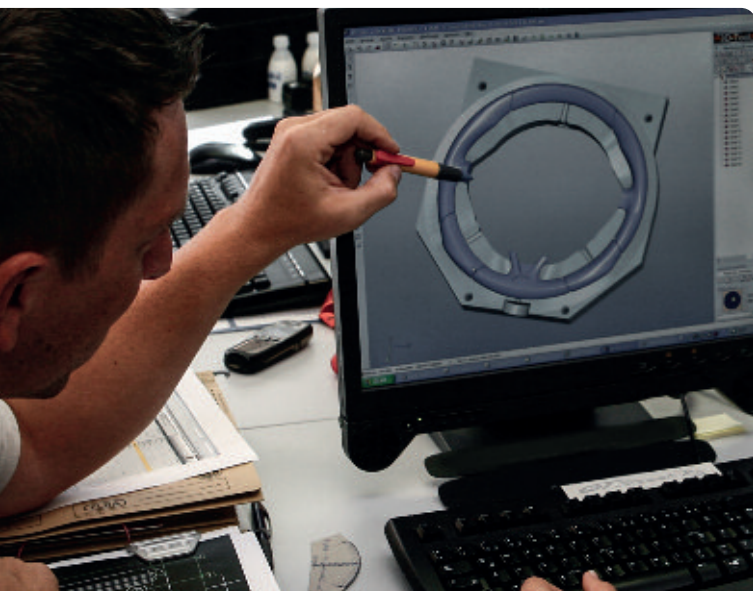

Konstruktion der Gusswerkzeuge für die ergonomisch geformten TECHART Sportlenkräder.
Design of the casting molds for the ergonomically shaped TECHART sport steering wheels.



Bereits im handgefertigten Designmodell wird die spätere Lage der Lederbiesen berücksichtigt.
Already in the handmade design model, subsequent leather piping has to be considered.

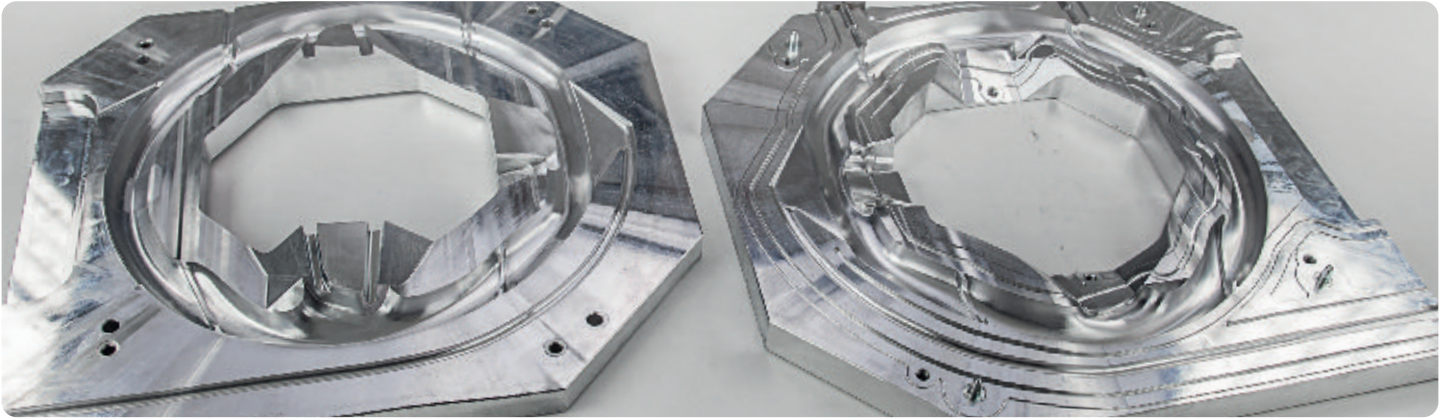

Zuständig für die ergonomische Form typischer TECHART Sportlenkräder sind die Formwerkzeuge, die zur Herstellung des Lenkradkranzes in der TECHART Manufaktur eingesetzt werden. Proprietary molding tools are used in TECHART's inhouse manufactory to produce the steering wheel rims featuring the distinctive and ergonomic shape TECHART steering wheels are renowned for.



Ein Zeichen wertvoller Handarbeit: das TECHART Lenkrademblem.
A sign of precious craftsmanship: the TECHART steering wheel emblem.



Serienlenkräder | Standard Steering Wheels

■ 991/I bis Modelljahr 2016	■ 991/I up to MY 2016
□ 991/II ab Modelljahr 2017	□ 991/II as of MY 2017
● beide 991 Generationen	● both 991 generations

Individualisierung/Aufarbeitung Serienlenkrad
 Auch für große und kleine Wünsche rund um Ihr Serienlenkrad stehen wir Ihnen gerne zur Verfügung. Wie wäre es mit neuem, weichem Leder, einer handgefertigten Ziernaht oder anderen Verfeinerungen aus dem Repertoire der TECHART Manufaktur? Sprechen Sie mit uns.

Individualization/Reconditioning OE wheel
 As for your standard steering wheel, too, we are happy to fulfill your desires. How about new supple leather for your steering wheel or a hand-sewed stitching? The full repertoire of TECHART's master craftsmen is at your service. Please contact us.

911 Carrera / Carrera Cabriolet	●	911 Carrera / Carrera Cabriolet	●
911 Carrera S / Carrera S Cabriolet	●	911 Carrera S / Carrera S Cabriolet	●
911 Carrera 4 / Carrera 4 Cabriolet	●	911 Carrera 4 / Carrera 4 Cabriolet	●
911 Carrera 4S / Carrera 4S Cabriolet	●	911 Carrera 4S / Carrera 4S Cabriolet	●
911 Targa 4 / Targa 4S	●	911 Targa 4 / Targa 4S	●
911 GTS / 4 GTS / Targa 4 GTS	●	911 GTS / 4 GTS / Targa 4 GTS	●
911 GT3 / GT3 RS	●	911 GT3 / GT3 RS	●
911 Turbo / Turbo Cabriolet	●	911 Turbo / Turbo Cabriolet	●
911 Turbo S / Turbo S Cabriolet	●	911 Turbo S / Turbo S Cabriolet	●

TECHART »Typ 3« | »Type 3«

<p>TECHART 3-Speichen Sportlenkrad Durchmesser 370 mm, ergonomisch geformt und gepolstert, passend für original Airbageinheit, handvernähtes Leder mit Ziernaht</p> <p>Typ 3 in Leder schwarz Typ 3 in Leder, Wunschfarbe Typ 3 in Leder/ Aluoptik Typ 3 in Leder/Kohlefaser Typ 3 in Leder/Kohlefaser¹</p> <p>¹ für Fahrzeuge mit Kohlefaser-Zierteilen ab Werk. Die Anordnung der Faserstruktur wird passend zur vorhandenen Optik ausgeführt.</p>	<p>TECHART 3-spokes sport steering wheel Diameter 370 mm, ergonomically shaped and padded, fits OE airbag unit, hand-sewed leather with decorative stitching</p> <p>Type 3 in leather black Type 3 in leather, custom color Type 3 in leather/ aluminium look Type 3 in leather/carbon fiber Type 3 in leather/carbon fiber¹</p> <p>¹ for vehicles with OE carbon trims. The fiber structure layout is designed to match the existing texture.</p>	<p>097.430.373.201 097.430.373.CCC 097.430.373.CCC/AL 097.430.373.CCC/CF 097.430.373.CCC/PC</p>	<p>911 Carrera / Carrera Cabriolet</p> <p>911 Carrera S / Carrera S Cabriolet</p> <p>911 Carrera 4 / Carrera 4 Cabriolet</p> <p>911 Carrera 4S / Carrera 4S Cabriolet</p> <p>911 Targa 4 / Targa 4S</p> <p>911 GTS / 4 GTS / Targa 4 GTS</p> <p>911 GT3 / GT3 RS</p> <p>911 Turbo / Turbo Cabriolet</p> <p>911 Turbo S / Turbo S Cabriolet</p>
<p>Lenkradblende in Leder in Wunschfarbe in Kohlefaser, glänzend in Kohlefaser, matt in Kohlefaser¹</p> <p>¹ für Fahrzeuge mit Kohlefaser-Zierteilen ab Werk. Die Anordnung der Faserstruktur wird passend zur vorhandenen Optik ausgeführt.</p>	<p>Steering wheel frame in leather in custom color in carbon fiber, glossy finish in carbon fiber, matt finish in carbon fiber¹</p> <p>¹ for vehicles with OE carbon trims. The fiber structure layout is designed to match the existing texture.</p>	<p>097.407.128.997 097.408.128.998 097.421.128.100 097.421.128.100M 097.421.128.100PC</p>	<p>911 Carrera / Carrera Cabriolet</p> <p>911 Carrera S / Carrera S Cabriolet</p> <p>911 Carrera 4 / Carrera 4 Cabriolet</p> <p>911 Carrera 4S / Carrera 4S Cabriolet</p> <p>911 Targa 4 / Targa 4S</p> <p>911 GTS / 4 GTS / Targa 4 GTS</p> <p>911 GT3 / GT3 RS</p> <p>911 Turbo / Turbo Cabriolet</p> <p>911 Turbo S / Turbo S Cabriolet</p>
<p>Minderpreis bei Rückführung Ihres Originalenlenkrades. Bitte sprechen Sie mit Ihrem TECHART Vertriebsmitarbeiter.</p>	<p>Refund on return of your OE steering wheel. Please contact your sales team at TECHART for conditions</p>		



Typ 3 in Leder und perforiertem Alcantara, mit Segment in Aluminium Optik.
 Type 3 in leather and perforated Alcantara, with segment in aluminium look.



Typ 3 in Alcantara mit Lenkradblende in Riviera Blau matt, passender 12-Uhr-Markierung und Kreuznaht.
 Type 3 in Alcantara with frame in Riviera Blue matt, straight-ahead-marker and cross-over stitching.

TECHART »Typ 4« | »Type 4«

- | | |
|-----------------------------|------------------------|
| ■ 991/I bis Modelljahr 2016 | ■ 991/I up to MY 2016 |
| □ 991/II ab Modelljahr 2017 | □ 991/II as of MY 2017 |
| ● beide 991 Generationen | ● both 991 generations |

- 911 Carrera / Carrera Cabriolet
- 911 Carrera S / Carrera S Cabriolet
- 911 Carrera 4 / Carrera 4 Cabriolet
- 911 Carrera 4S / Carrera 4S Cabriolet
- 911 Targa 4 / Targa 4S
- 911 GTS / 4 GTS / Targa 4 GTS
- 911 GT3 / GT3 RS
- 911 Turbo / Turbo Cabriolet
- 911 Turbo S / Turbo S Cabriolet

<p>TECHART 3-Speichen Sportlenkrad für Fahrzeuge mit PDK Getriebe Durchmesser 370 mm, ergonomisch geformt und gepolstert, passend für original Airbageinheit, handvernähtes Leder mit Ziernaht</p> <p>Typ 4 in Leder, Individualfarbe Typ 4 in Leder/Kohlefaser Typ 4 in Leder/Kohlefaser¹</p> <p>¹ für Fahrzeuge mit Kohlefaser-Zierteilen ab Werk. Die Anordnung der Faserstruktur wird passend zur vorhandenen Optik ausgeführt.</p> <p>Original Schaltpaddles in Individualfarbe Original Schaltpaddle Rückseite in Leder</p>	<p>TECHART 3-spokes sport steering wheel for vehicles with PDK transmission Diameter 370 mm, ergonomically shaped and padded, fits OE airbag unit, hand-sewed leather with decorative stitching</p> <p>Type 4 in leather, custom color Type 4 in leather/carbon fiber Type 4 in leather/carbon fiber¹</p> <p>¹ for vehicles with OE carbon trims. The fiber structure layout is designed to match the existing texture.</p> <p>OE paddle shifters in custom color OE paddle shifters, back side in leather</p>	<p>097.430.374.CCC 097.430.374.CCC/CF 097.430.374.CCC/PC</p> <p>097.408.127.998 097.407.127.997</p>	<table border="1"> <tr><td>■</td><td>■</td><td>■</td><td>■</td><td>■</td><td>■</td><td>■</td><td>■</td><td>■</td><td>■</td></tr> <tr><td>1</td><td>1</td><td>1</td><td>1</td><td>1</td><td>1</td><td>1</td><td>1</td><td>1</td><td>1</td></tr> <tr><td>■</td><td>■</td><td>■</td><td>■</td><td>■</td><td>■</td><td>■</td><td>■</td><td>■</td><td>■</td></tr> <tr><td>■</td><td>■</td><td>■</td><td>■</td><td>■</td><td>■</td><td>■</td><td>■</td><td>■</td><td>■</td></tr> </table>	■	■	■	■	■	■	■	■	■	■	1	1	1	1	1	1	1	1	1	1	■	■	■	■	■	■	■	■	■	■	■	■	■	■	■	■	■	■	■	■
■	■	■	■	■	■	■	■	■	■																																		
1	1	1	1	1	1	1	1	1	1																																		
■	■	■	■	■	■	■	■	■	■																																		
■	■	■	■	■	■	■	■	■	■																																		
<p>Lenkradblende in Wunschfarbe</p> <p>Minderpreis bei Rückführung Ihres Originallenkrades. Bitte sprechen Sie mit Ihrem TECHART Vertriebsmitarbeiter.</p>	<p>Steering wheel frame in custom color</p> <p>Refund on return of your OE steering wheel. Please contact your sales team at TECHART for conditions.</p>	<p>097.408.128.998</p>	<table border="1"> <tr><td>■</td><td>■</td><td>■</td><td>■</td><td>■</td><td>■</td><td>■</td><td>■</td><td>■</td><td>■</td></tr> <tr><td>■</td><td>■</td><td>■</td><td>■</td><td>■</td><td>■</td><td>■</td><td>■</td><td>■</td><td>■</td></tr> </table>	■	■	■	■	■	■	■	■	■	■	■	■	■	■	■	■	■	■	■	■																				
■	■	■	■	■	■	■	■	■	■																																		
■	■	■	■	■	■	■	■	■	■																																		



Typ 4 in Leder und perforiertem Leder mit rot lackierten original Schaltpaddles und 12-Uhr-Markierung.
Type 4 in leather and perforated leather with red painted OE paddle shifters and straight-ahead-marker.



Typ 4 in zweifarbigem Leder mit 12-Uhr-Markierung, Blende und original Schaltpaddles in schwarz.
Type 4 in two-tone leather with straight-ahead-marker, frame and OE paddle shifters in gloss black.



Typ 4 in Alcantara mit orange hinterlegter Perforierung, Blende und original Schaltpaddles in mattschwarz.
Type 4 in Alcantara, perforated segment with orange backing, frame and OE paddle shifters in matt black.



Typ 4 mit Kranz und Airbag in Alcantara, Blende in gelb und original Schaltpaddles in mattschwarz.
Type 4 with rim and airbag in Alcantara, frame in yellow and OE paddle shifters in matt black.

TECHART »Typ PDK« | »Type PDK«

■ 991/I bis Modelljahr 2016	■ 991/I up to MY 2016
□ 991/II ab Modelljahr 2017	□ 991/II as of MY 2017
● beide 991 Generationen	● both 991 generations

911 Carrera / Carrera Cabriolet
911 Carrera S / Carrera S Cabriolet
911 Carrera 4 / Carrera 4 Cabriolet
911 Carrera 4S / Carrera 4S Cabriolet
911 Targa 4 / Targa 4S
911 GTS / 4 GTS / Targa 4 GTS
911 GT3 / GT3 RS
911 Turbo / Turbo Cabriolet
911 Turbo S / Turbo S Cabriolet

TECHART 3-Speichen Sportlenkrad für Fahrzeuge mit PDK Getriebe

Durchmesser 370 mm, ergonomisch geformt und gepolstert, passend für original Airbageinheit, handvernähtes Leder mit Ziernaht

- Typ PDK in Leder schwarz
- Typ PDK in Leder, Individualfarbe
- Typ PDK in Leder/Klavierlack
- Typ PDK in Leder/Aluoptik
- Typ PDK in Leder/Kohlefaser
- Typ PDK in Leder/Kohlefaser¹

¹ für Fahrzeuge mit Kohlefaser-Zierteilen ab Werk. Die Anordnung der Faserstruktur wird passend zur vorhandenen Optik ausgeführt.

TECHART 3-spokes sport steering wheel for vehicles with PDK transmission

Diameter 370 mm, ergonomically shaped and padded, fits OE airbag unit, hand-sewed leather with decorative stitching

- Type PDK in leather black
- Type PDK in leather, custom color
- Type PDK in leather/piano lacquer
- Type PDK in leather/aluminium
- Type PDK in leather/carbon fiber
- Type PDK in leather/carbon fiber¹

¹ for vehicles with OE carbon trims. The fiber structure layout is designed to match the existing texture.

- 097.430.372.201
- 097.430.372.CCC
- 097.430.372.CCC/PP
- 097.430.372.CCC/AL
- 097.430.372.CCC/CF
- 097.430.372.CCC/PC

■	■	■	■	■	■	■	■	■	■
■	■	■	■	■	■	■	■	■	■
■	■	■	■	■	■	■	■	■	■
■	■	■	■	■	■	■	■	■	■
■	■	■	■	■	■	■	■	■	■
■	■	■	■	■	■	■	■	■	■
■	■	■	■	■	■	■	■	■	■
■	■	■	■	■	■	■	■	■	■
■	■	■	■	■	■	■	■	■	■
■	■	■	■	■	■	■	■	■	■

Lenkradblende in Leder

- in Leder
- in Wunschfarbe
- in Kohlefaser, glänzend
- in Kohlefaser, matt
- in Kohlefaser¹

¹ für Fahrzeuge mit Kohlefaser-Zierteilen ab Werk. Die Anordnung der Faserstruktur wird passend zur vorhandenen Optik ausgeführt.

Steering wheel frame in leather

- in leather
- in custom color
- in carbon fiber, glossy finish
- in carbon fiber, matt finish
- in carbon fiber¹

¹ for vehicles with OE carbon trims. The fiber structure layout is designed to match the existing texture.

- 097.407.123.997
- 097.408.121.998
- 097.421.121.100
- 097.421.121.100M
- 097.421.121.100PC

■	■	■	■	■	■	■	■	■	■
■	■	■	■	■	■	■	■	■	■
■	■	■	■	■	■	■	■	■	■
■	■	■	■	■	■	■	■	■	■
■	■	■	■	■	■	■	■	■	■
■	■	■	■	■	■	■	■	■	■
■	■	■	■	■	■	■	■	■	■
■	■	■	■	■	■	■	■	■	■
■	■	■	■	■	■	■	■	■	■
■	■	■	■	■	■	■	■	■	■

Minderpreis bei Rückführung Ihres Originallenkrades. Bitte sprechen Sie mit Ihrem TECHART Vertriebsmitarbeiter.

Refund on return of your OE steering wheel. Please contact your sales team at TECHART for conditions.



Typ PDK in Leder und Carbon mit gelben Lederbiesen, Blende und TECHART Paddles in schwarz.
Type PDK in leather and carbon with yellow leather piping, frame and TECHART paddles in black.



Typ PDK in Leder, Blende und TECHART Paddles in weiß sowie Airbag mit roter Ziernaht.
Type PDK in leather, frame and TECHART paddles painted in white, airbag with red stitching.



Typ 7 in Alcantara und Carbon mit roter Ziernaht, 12-Uhr-Markierung und blauen Akzentteilen.
Type 7 in Alcantara and carbon fiber with red stitching, straight-ahead-marker and blue highlights.



Typ PDK in Leder, Lenkradkranz im Segmenten in Aluminium Optik, TECHART Paddles in silber.
Type PDK in leather, steering wheel rim segments in aluminum look, TECHART paddles in silver.







TECHART Schaltpaddles

TECHART Paddle Shifters

Schalten wie im Motorsport. TECHART erfüllt Ihnen diesen Wunsch. Die TECHART Schaltpaddles sind für alle Porsche Multifunktions- oder Sportlenkräder mit Schiebetasten nachrüstbar.

Die ergonomisch angebrachten Paddles ermöglichen jederzeit schnelle und präzise Schaltvorgänge, auch beim schnellen Einlenken und sportiver Fahrweise. Mit einem Zug rechts schaltet Ihr Tiptronic S Getriebe einen Gang nach oben, mit einem Zug links einen Gang nach unten. Motorsport Feeling garantiert – auf der Rennstrecke und auf der Straße. Kompromisslos sportlich und uneingeschränkt alltagstauglich.

Für eine hochwertige Haptik und eine angenehme Temperatur der Paddle-Oberfläche – auch bei intensiver Sonneneinstrahlung – sorgt das hochwertige Material der Paddles: hochfestes ABS Polymer. Äußerst schlagstabil, zugfest und kratzbeständig. Wahlweise in Aluminiumoptik, in Wunschfarbe lackiert oder mit feinem Alcantara bezogen.

Alle Porsche Sport- und Multifunktionslenkräder mit Schiebetasten sowie alle TECHART Typ PDK Sportlenkräder sind modellübergreifend auf TECHART Schaltpaddles umrüstbar. Und für noch mehr Individualität stehen nahezu unbegrenzte Farb- und Materialkombinationen für Ihr Lenkrad bereit.

Motorsport-like gear changes – the TECHART paddle shifters let you upgrade your Porsche sport steering wheel or multifunction steering wheel featuring the standard gearshift switches.

The ergonomically-designed paddle shifters enable precise and rapid gear changes at any time, which allows you to concentrate on your racing line and cornering speed. Tiptronic S shifts up by pulling the right paddle, a pull of the left paddle and the Tiptronic S shifts down. Uncompromisingly sporty on track and perfect for everyday driving pleasure on road, motorsport feeling guaranteed.

For a high-quality look and feel and to ensure a pleasant paddle temperature at all times without heating due to insolation, the paddles are made of premium material: high-strength ABS polymer. This combines important mechanical properties like strength, rigidity and toughness. Available in aluminum look, custom color finish or covered in supple Alcantara.

All Porsche sport steering wheels and multifunction steering wheels with gearshift switches are convertible with TECHART paddle shifters, and so are all TECHART type PDK sport steering wheels. And for the individual touch, unlimited combinations of materials and colors are at your choice.



Original Lenkrad mit Schiebetasten vor der Umrüstung.
OE steering wheel with gearshift switches before modification.



Lenkrad mit TECHART Schaltpaddles. Eine ergonomische Blende ersetzt die Schiebetasten.
Steering wheel with TECHART paddle shifters. An ergonomic trim replaces the gearshift switch.

■ 991/I bis Modelljahr 2016	■ 991/I up to MY 2016
□ 991/II ab Modelljahr 2017	□ 991/II as of MY 2017
● beide 991 Generationen	● both 991 generations

911 Carrera / Carrera Cabriolet
911 Carrera S / Carrera S Cabriolet
911 Carrera 4 / Carrera 4 Cabriolet
911 Carrera 4S / Carrera 4S Cabriolet
911 Targa 4 / Targa 4S
911 GTS / 4 GTS / Targa 4 GTS
911 GT3 / GT3 RS
911 Turbo / Turbo Cabriolet
911 Turbo S / Turbo S Cabriolet

TECHART Schaltpaddles zur Nachrüstung
nur für Fahrzeuge mit Tiptronic S-Lenkrad
(mit Schiebetasten)

in Galvano Silber
in Individualfarbe
in Individualfarbe mit »+« und »-« Symbolen
in Leder/Alcantara mit »+« und »-« Symbolen

TECHART paddle shifters retrofit
only for vehicles with Tiptronic S steering
wheel (with sliding gearshift buttons)

in Galvano Silber
in custom color
in custom color with »+« and »-« symbols
in leather/Alcantara with »+« and »-« symbols

000.430.400.009-01
000.430.400.CCC-01
000.430.401.CCC-01
000.430.407.CCC-01

■	■	■	■	■	■	■	■	■	■
■	■	■	■	■	■	■	■	■	■
■	■	■	■	■	■	■	■	■	■
■	■	■	■	■	■	■	■	■	■



TECHART Lenkrad Typ PDK in schwarzem Naturleder und Schaltpaddles in Alcantara.
TECHART steering wheel Type PDK in black natural leather with paddles in Alcantara.



Ton in Ton: Paddles in Alcantara mit farblich auf die Ziernähte abgestimmten Symbolen.
Matching colors: paddles in Alcantara with color-coordinated symbols and stitching.



TECHART Schaltpaddles in mattblau metallic mit weiß auslackierten Symbolen.
TECHART Paddle Shifters in matt blue metallic with white lacquered symbols.



TECHART Schaltpaddles in rot hochglänzend mit schwarz auslackierten Symbolen.
TECHART Paddle Shifters in gloss red with white lacquered symbols.



TECHART Schaltpaddles in weiß hochglänzend mit rot auslackierten Symbolen.
TECHART Paddle Shifters in gloss whitewith red lacquered symbols.



TECHART Schaltpaddles in Alcantara.
TECHART Paddle Shifters in Alcantara.



Zusatzoptionen für Lenkräder

Optional steering wheel details

Veredelung | Refinement

- 991/I bis Modelljahr 2016
- 991/II ab Modelljahr 2017
- beide 991 Generationen
- 991/I up to MY 2016
- 991/II as of MY 2017
- both 991 generations

911 Carrera / Carrera Cabriolet
 911 Carrera S / Carrera S Cabriolet
 911 Carrera 4 / Carrera 4 Cabriolet
 911 Carrera 4S / Carrera 4S Cabriolet
 911 Targa 4 / Targa 4S
 911 GTS / 4 GTS / Targa 4 GTS
 911 GT3 / GT3 RS
 911 Turbo / Turbo Cabriolet
 911 Turbo S / Turbo S Cabriolet

Airbageinheit in Leder mit TECHART Emblem mit TECHART Emblem & Ziernaht	Airbag unit in leather with TECHART emblem with TECHART emblem & decorative stitching	058.407.121.997 058.407.122.997	● ● ● ● ● ● ● ● ● ● ● ● ● ● ● ● ● ● ● ●
Unterlegung für Perforation <small>³ für Lenkrad Typ 3</small>	Backing for perforation <small>³ for steering wheel Type 3</small>	000.437.111.997	3 3 3 3 3 3 3 3 3 3



Airbageinheit in Alcantara mit weißer Ziernaht und TECHART Emblem.
Airbag unit in Alcantara with white stitching and TECHART emblem.



Perforiertes Alcantara, akzentuiert mit einer Unterlegung in orange.
Perforated Alcantara, highlighted by a backing in orange.

12-Uhr-Markierungen | Straight-ahead-markers

- | | |
|-----------------------------|------------------------|
| ■ 991/I bis Modelljahr 2016 | ■ 991/I up to MY 2016 |
| □ 991/II ab Modelljahr 2017 | □ 991/II as of MY 2017 |
| ● beide 991 Generationen | ● both 991 generations |

- 911 Carrera / Carrera Cabriolet
- 911 Carrera S / Carrera S Cabriolet
- 911 Carrera 4 / Carrera 4 Cabriolet
- 911 Carrera 4S / Carrera 4S Cabriolet
- 911 Targa 4 / Targa 4S
- 911 GT3 / 4 GT3 / Targa 4 GT3
- 911 GT3 / GT3 RS
- 911 Turbo / Turbo Cabriolet
- 911 Turbo S / Turbo S Cabriolet

12 Uhr Markierung	Straight-ahead marker	000.437.110.997 000.430.110.CCC
¹ für Lenkrad Typ 3 und Typ PDK ² für Lenkräder mit Kohlefaser Segment	¹ for steering wheel Type 3 and Type PDK ² for steering wheels with carbon fiber segment	

1	1	1	1	1	1	1	1	1
2	2	2	2	2	2	2	2	2



12-Uhr-Markierung in Form einer schmalen Lederbiege, kombiniert mit Alcantara.
Straight-ahead-marker made of a thin leather piping, combined with Alcantara.



12-Uhr-Markierung als Doppelbiege in Acid Green ausgeführt.
Straight-ahead-marker made of a double piping in Acid Green.



Breite 12-Uhr-Markierung in weiß, eingefasst mit Zierfäden aus blauem Garn.
Broad straight-ahead-marker in white, edged by blue decorative threads.

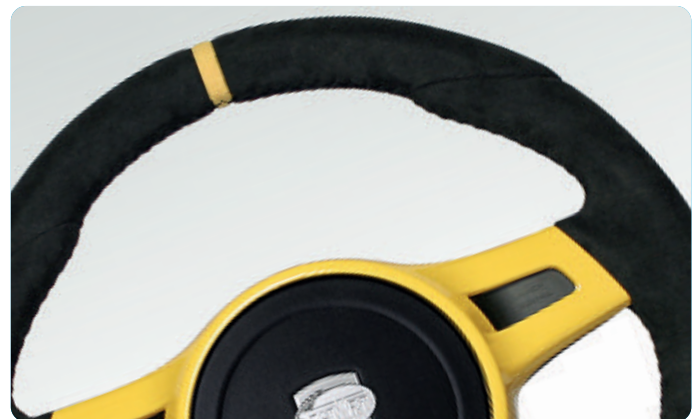

Breite 12-Uhr-Markierung in gelb, kombiniert mit Alcantara.
Broad straight-ahead-marker in yellow, combined with Alcantara.



Breite 12-Uhr-Markierung in blau, kombiniert mit Alcantara.
Broad straight-ahead-marker in blue, combined with Alcantara.



Kohlenstoffsegment mit rot lackierter 12-Uhr-Markierung.
Carbon segment with red lacquered straight-ahead-marker.



FERRARI





TECHART Interieur in schwarzem und rotem Leder mit weißen Ziernähten sowie mit Zierteilen in Wagenfarbe lackiert.



TECHART interior in black and red leather, combined with white stitching and interior trims painted in body color.

Interieur Manufaktur

Interior Manufactory

Armaturentafel & Mittelkonsole | Dashboard & center console

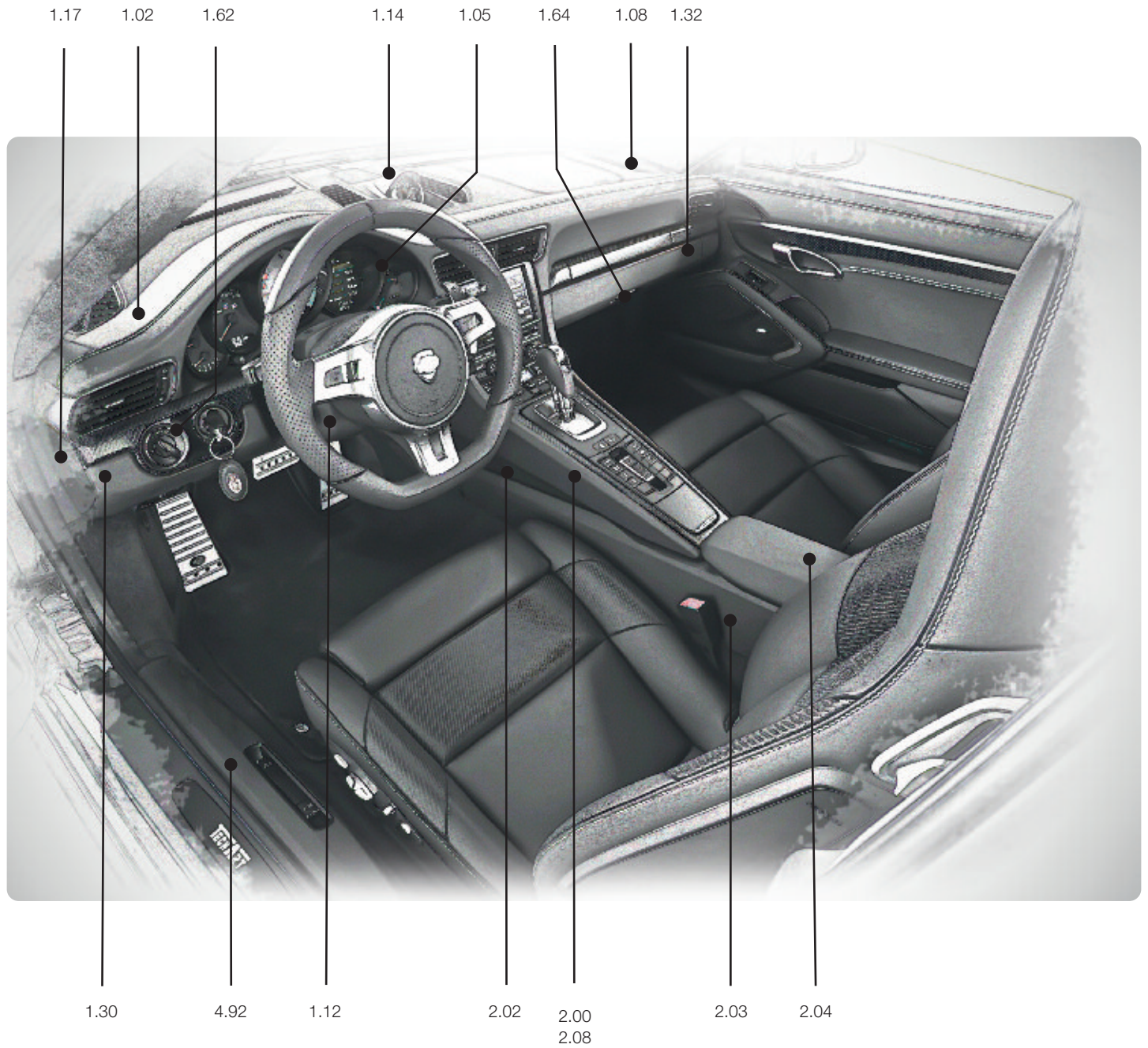

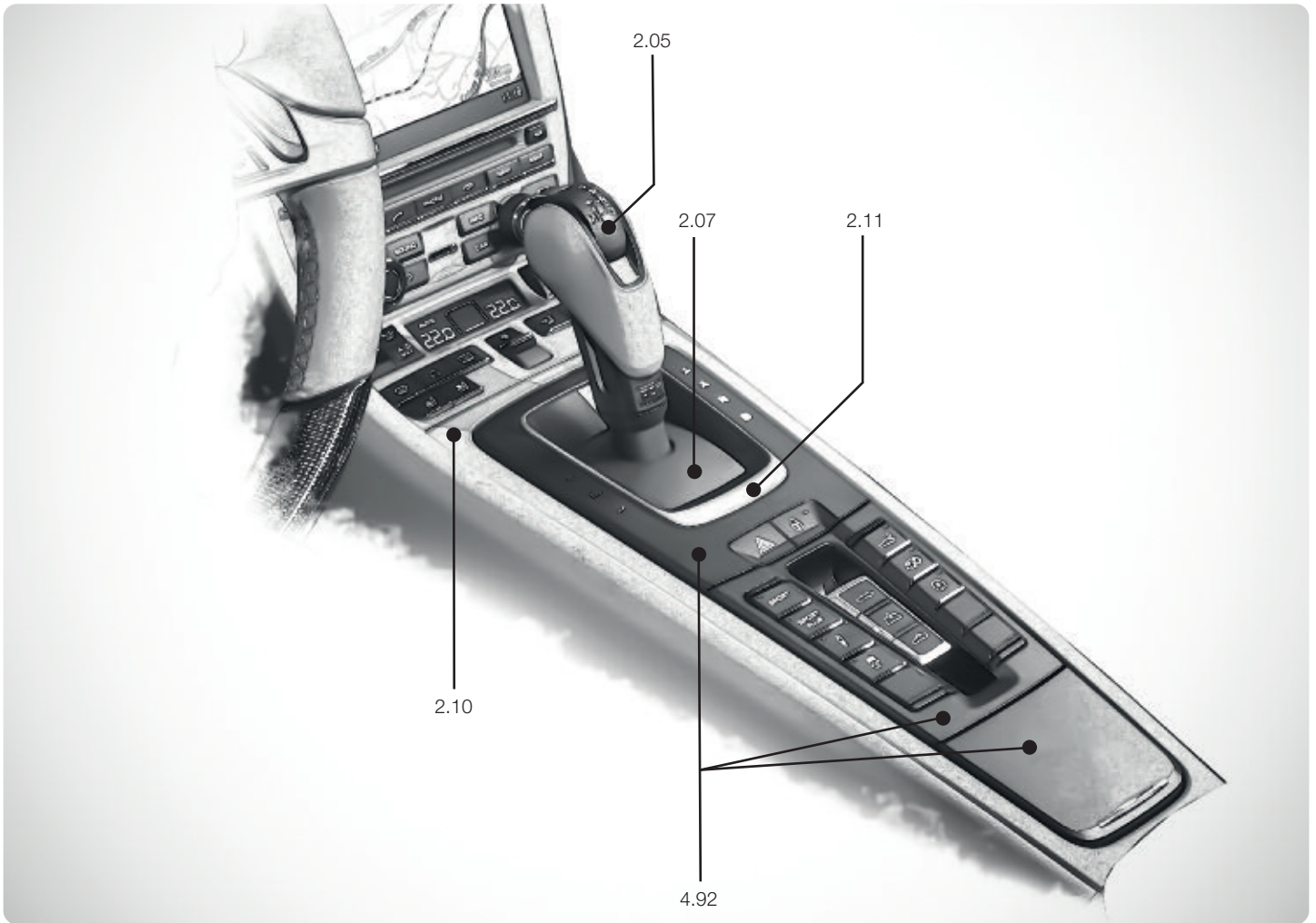

- | | |
|-----------------------------|------------------------|
| ■ 991/I bis Modelljahr 2016 | ■ 991/I up to MY 2016 |
| □ 991/II ab Modelljahr 2017 | □ 991/II as of MY 2017 |
| ● beide 991 Generationen | ● both 991 generations |

- 911 Carrera / Carrera Cabriolet
- 911 Carrera S / Carrera S Cabriolet
- 911 Carrera 4 / Carrera 4 Cabriolet
- 911 Carrera 4S / Carrera 4S Cabriolet
- 911 Targa 4 / Targa 4S
- 911 GTS / 4 GTS / Targa 4 GTS
- 911 GT3 / GT3 RS
- 911 Turbo / Turbo Cabriolet
- 911 Turbo S / Turbo S Cabriolet

Option	Code	911 Carrera / Carrera Cabriolet	911 Carrera S / Carrera S Cabriolet	911 Carrera 4 / Carrera 4 Cabriolet	911 Carrera 4S / Carrera 4S Cabriolet	911 Targa 4 / Targa 4S	911 GTS / 4 GTS / Targa 4 GTS	911 GT3 / GT3 RS	911 Turbo / Turbo Cabriolet	911 Turbo S / Turbo S Cabriolet
Dachhimmleinheit in Alcantara mit Ziernaht, inklusive Säulenverkleidungen sowie Dachverkleidung hinten in Leder <small>¹ für Fahrzeuge mit Schiebe-/Hubdach</small>	Rooflining in Alcantara with decorative stitching, includes pillar trims and rear roofing trim in leather <small>¹ for vehicles with slide/tilt sunroof</small>	091.407.300.997	091.407.303.997	●	●	●	●	●	●	●
Verdeckabdeckung Cabrio in Leder	Top cover convertible in leather	091.407.301.997		●	●	●	●	●	●	●
Blende Innenraumleuchten in Leder in Wunschfarbe	Panel interior lighting in leather in custom color	091.407.310.997	091.408.310.998	●	●	●	●	●	●	●
Sonnenblenden in Leder für Fahrzeuge mit heller Innenausstattung für Cabrios	Sun visors in leather for vehicles with bright Interior for Convertibles	091.407.315.997	091.407.315.997CSW 091.407.315.997SW	●	●	●	●	●	●	●
Kosmetikspiegelklappen	Vanity mirror flaps	091.407.316.997		●	●	●	●	●	●	●
Rückspiegel in Leder	Rear view mirror in leather	091.407.320.997		●	●	●	●	●	●	●
Rückspiegelblenden in Leder	Panels rear view mirror in leather	091.407.322.997		●	●	●	●	●	●	●



Sitze | Seats



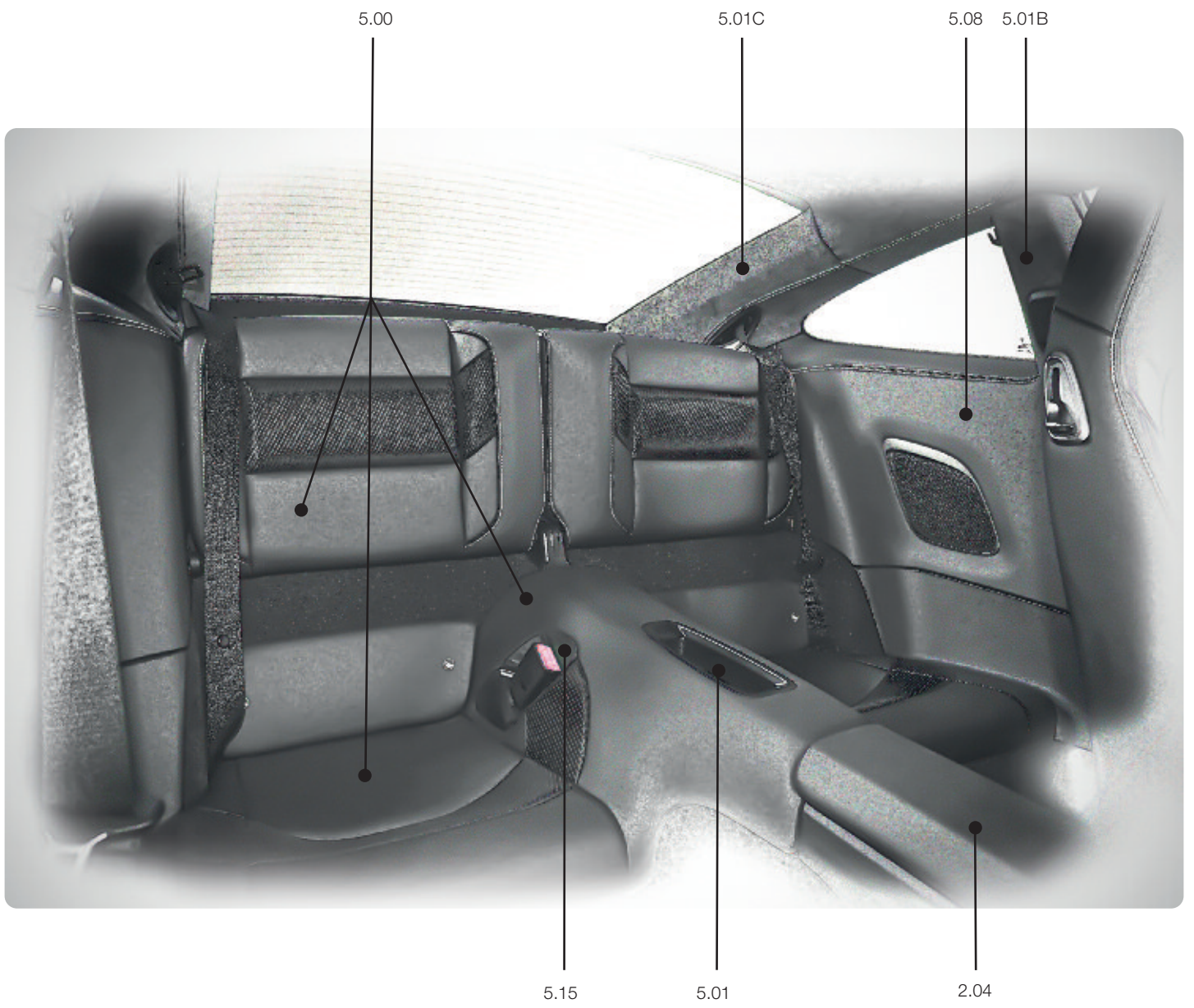



Sportbetontes Interieurdesign für ein 911 GTS Modell. Blaue Elemente übertragen das Performance-Dekor der Karosserie in den Innenraum.



Interior sport design for a 911 GTS model. Blue elements transfer the performance styling of the vehicle's body into the interior.









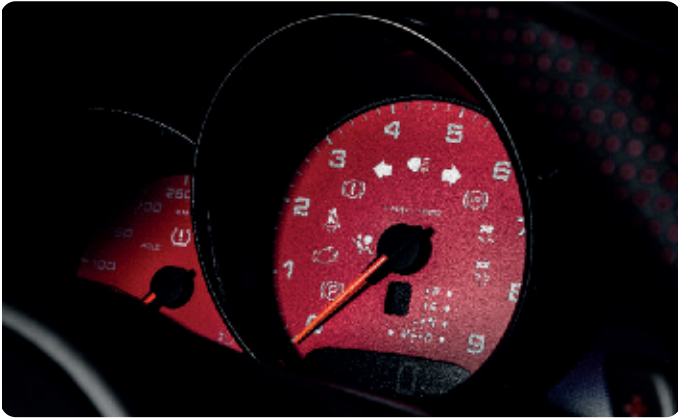

Farblich abgestimmte Instrumentenzifferblätter.
Color-matched instrument dials.



Zifferblatt und Ziernähte in blau.
Dial and stitching in blue.

- | | |
|-----------------------------|------------------------|
| ■ 991/I bis Modelljahr 2016 | ■ 991/I up to MY 2016 |
| □ 991/II ab Modelljahr 2017 | □ 991/II as of MY 2017 |
| ● beide 991 Generationen | ● both 991 generations |

- 911 Carrera / Carrera Cabriolet
- 911 Carrera S / Carrera S Cabriolet
- 911 Carrera 4 / Carrera 4 Cabriolet
- 911 Carrera 4S / Carrera 4S Cabriolet
- 911 Targa 4 / Targa 4S
- 911 GTS / 4 GTS / Targa 4 GTS
- 911 GT3 / GT3 RS
- 911 Turbo / Turbo Cabriolet
- 911 Turbo S / Turbo S Cabriolet

TECHART Instrumentenzifferblätter in Individualfarbe, Skalierung in km/h	TECHART instrument dials in custom color, km/h scale	091.530.510.CCC 091.530.512.CCC 091.530.520.CCC 091.530.522.CCC 091.530.540.CCC 091.530.550.CCC 091.530.570.CCC	1 1 1 1 1 1 1 1 1 1 1 1 2 2 2 2 2 2 2 2 2 2 2 2
in Individualfarbe, Skalierung in mph	in custom color, mph scale	091.530.521.CCC 091.530.541.CCC 091.530.551.CCC	2 2 2 2 2 2
Sport Chrono Zifferblatt in Individualfarbe	Sport Chrono dial in custom color	097.530.590.CCC	2 2 2 2 2 2
Aluminium Sportpedalerie 3-teilig, eloxiert, mit TECHART Logo 3-teilig, titangrau, eloxiert, mit TECHART Logo 2-teilig, eloxiert, mit TECHART Logo 2-teilig, titangrau, eloxiert, mit TECHART Logo	Aluminum sport pedals 3 pcs., anodized, with TECHART Logo 3 pcs., titanium grey, anodized, with TECHART Logo 2 pcs., anodized, with TECHART Logo 2 pcs., titanium grey, anodized, with TECHART Logo	097.460.400.009 097.460.450.009 097.460.401.009 097.460.451.009	1 1 1 1 1 1 1 1 1 1 1 1 2 2 2 2 2 2 2 2 2 2 2 2
Aluminium Fußstütze eloxiert, mit TECHART Logo	Aluminum foot rest anodized, with TECHART Logo	097.460.402.009 097.460.412.009	1 1 1 1 1 1 2 2 2 2 2 2
titangrau, eloxiert, mit TECHART Logo	titanium grey, anodized, with TECHART Logo	097.460.452.009 097.460.462.009	1 1 1 1 1 1 2 2 2 2 2 2
TECHART Fußmattensatz Teppich und Ledereinfassung in Individual- farbe, mit gesticktem TECHART Schriftzug	TECHART floor mats carpet and leather piping in custom color, with embroidered TECHART logotype	091.410.400.CCC 091.410.420.CCC 091.410.401.CCC 091.410.421.CCC	1 1 1 1 1 1 2 2 2 2 2 2 1 1 1 1 1 1 2 2 2 2 2 2
¹ für Fahrzeuge mit Schaltgetriebe ² für Fahrzeuge mit PDK	¹ for vehicles with manual gearbox ² for vehicles with PDK		
¹ für Linkslenker Fahrzeuge ² für Rechtslenker Fahrzeuge	¹ for left-hand drive vehicles ² for right-hand drive vehicles		
¹ für Linkslenker Fahrzeuge ² für Rechtslenker Fahrzeuge	¹ for left-hand drive vehicles ² for right-hand drive vehicles		



TECHART Interior in schwarzem Leder mit Ziernähten in Acid Green, dazu passend lackierte Kunststoffteile sowie Zierleisten an Mittelkonsole, Instrumententafel und Türen in Carbon.
TECHART interior in black leather with stitching in Acid green and color-matched plastic parts. Trims at doors, dashboard and center console in carbon fiber.

		<div style="display: flex; justify-content: space-between;"> ■ 991/I bis Modelljahr 2016 ■ 991/I up to MY 2016 </div> <div style="display: flex; justify-content: space-between;"> □ 991/II ab Modelljahr 2017 □ 991/II as of MY 2017 </div> <div style="display: flex; justify-content: space-between;"> ● beide 991 Generationen ● both 991 generations </div>											
				911 Carrera / Carrera Cabriolet	911 Carrera S / Carrera S Cabriolet	911 Carrera 4 / Carrera 4 Cabriolet	911 Carrera 4S / Carrera 4S Cabriolet	911 Targa 4 / Targa 4S	911 GTS / 4 GTS / Targa 4 GTS	911 GT3 / GT3 RS	911 Turbo / Turbo Cabriolet	911 Turbo S / Turbo S Cabriolet	
TECHART Kofferraummatte Teppich und Ledereinfassung in Individualfarbe	TECHART loadspace floor mat carpet and leather piping in custom color	091.410.426.CCC	091.410.428.CCC	●	●	●	●	●	●	●	●	●	
TECHART Matte für Heckablage Teppich und Ledereinfassung in Individualfarbe	TECHART mat for rear shelf carpet and leather piping in custom color	091.410.800.CCC					●						
Lederlasche mit TECHART Emblem für Fußmatte 2 Stück 4 Stück	Leather strap with TECHART emblem for floor mat 2 pcs. 4 pcs.	000.410.101.CCC	000.410.100.CCC	●	●	●	●	●	●	●	●	●	
Lederlasche mit TECHART Emblem für Kofferraummatte	Leather strap with TECHART emblem for loadspace floor mat	000.410.102.CCC		●	●	●	●	●	●	●	●	●	
Sitzmittelbahn Vordersitz TECHART Design in Individualfarbe	Seat center front seats TECHART design in custom color	091.447.108.997		●	●	●	●	●	●	●	●	●	



Aus einem Guss: Umsetzung des TECHART Performance Fahrzeugdekors im Interieur.
Continuous design: the TECHART Performance body styling transferred to the interior.



Sportlich und wertvoll: TECHART Sitzrückenschalen aus Kohlefaser.
Sportive and precious: TECHART carbon fiber seat backpanels.



Zierteile und Sitzrückenschalen in Wagenfarbe, schwarzes Leder und rote Akzente. Hinweis auf versteckte Performance: die Sport Taste in rot.



Trims and seat backpanels in body color, a black leather interior and red highlights. A hint of hidden performance: the red Sport button.



- | | |
|-----------------------------|------------------------|
| ■ 991/I bis Modelljahr 2016 | ■ 991/I up to MY 2016 |
| □ 991/II ab Modelljahr 2017 | □ 991/II as of MY 2017 |
| ● beide 991 Generationen | ● both 991 generations |

- 911 Carrera / Carrera Cabriolet
- 911 Carrera S / Carrera S Cabriolet
- 911 Carrera 4 / Carrera 4 Cabriolet
- 911 Carrera 4S / Carrera 4S Cabriolet
- 911 Targa 4 / Targa 4S
- 911 GTS / 4 GTS / Targa 4 GTS
- 911 GT3 / GT3 RS
- 911 Turbo / Turbo Cabriolet
- 911 Turbo S / Turbo S Cabriolet

Türeinstiegsleisten beleuchtet		Illuminated door entry guards													
mit Inlay in Individualfarbe sowie mit beleuchtetem TECHART Schriftzug	with inlay in custom color and with illuminated TECHART logotype		091.460.351.009	●	●	●	●	●	●	●	●	●	●	●	●
mit Inlay in Individualfarbe sowie beleuchtetem personalisiertem Schriftzug	with inlay in custom color and with illuminated personalized logotype		091.460.353.CCC	●	●	●	●	●	●	●	●	●	●	●	●
Ziernähte in Individualfarbe		Decorative stitching in custom color													
Akzentuierung mit farblich abgesetztem Garn		Enhancement with contrasted yarn													
Sitzrückenschalen	Seat backpanels		091.407.021.997	●	●	●	●	●	●	●	●	●	●	●	●
Luftdüsen	Air nozzles		091.407.026.997	●	●	●	●	●	●	●	●	●	●	●	●
Defrosterblende	Defroster panel		091.407.027.997	●	●	●	●	●	●	●	●	●	●	●	●
Lenksäulenverkleidung	Steering column		091.407.028.997	●	●	●	●	●	●	●	●	●	●	●	●
Lautsprecherblende Armaturenbrett Mitte	Speaker panel dashboard center		091.407.036.997	●	●	●	●	●	●	●	●	●	●	●	●
Lautsprecherblende Armaturenbrett Seite	Speaker panel dashboard side		091.407.037.997	●	●	●	●	●	●	●	●	●	●	●	●
Lautsprecherblende Fondseitenverkleidung	Speaker panel rear side trim		091.407.043.997	●	●	●	●	●	●	●	●	●	●	●	●
Seitenblenden Armaturenbrett	Side panels dashboard		091.407.038.997	●	●	●	●	●	●	●	●	●	●	●	●
Ablagefach Rücksitz	Storage box, rear seat		091.407.046.997	●	●	●	●	●	●	●	●	●	●	●	●
Ziernähte Einstiegsleiste	Decorative seam door entry guards		091.407.047.997	●	●	●	●	●	●	●	●	●	●	●	●



Beleuchtete Einstiegsleiste mit TECHART Schriftzug.
Illuminated door entry guard with TECHART logotype.



Türtafel mit Ziernähten in weiß und einer roten Zierbiese als kraftvollem Akzent.
Door panel with white decorative stitching and an accentuating red leather piping.



Konsequente Detailverliebtheit zeugt von besonderem Anspruch. Weiches Leder und rote Akzente auch im 911-Fond.



Fascination with detail is an unmistakable sign of individualism. Supple leather and red highlights adorn the 911's rear, too.



Türzierleisten und Türöffner in Wagenfarbe lackiert.
Door trims and door opener painted in body color.



Kunststoff in edler Form: lackierte Blenden der PCM Einheit und der Klimaanlage-Bedientasten.
Plastic parts, tastefully refined: lacquered panels of the PCM and A/C controls.

- | | |
|-----------------------------|------------------------|
| ■ 991/I bis Modelljahr 2016 | ■ 991/I up to MY 2016 |
| □ 991/II ab Modelljahr 2017 | □ 991/II as of MY 2017 |
| ● beide 991 Generationen | ● both 991 generations |

- 911 Carrera / Carrera Cabriolet
- 911 Carrera S / Carrera S Cabriolet
- 911 Carrera 4 / Carrera 4 Cabriolet
- 911 Carrera 4S / Carrera 4S Cabriolet
- 911 Targa 4 / Targa 4S
- 911 GTS / 4 GTS / Targa 4 GTS
- 911 GT3 / GT3 RS
- 911 Turbo / Turbo Cabriolet
- 911 Turbo S / Turbo S Cabriolet

Interior Optikpaket V bestehend aus:	Interior Styling Package V consisting of:	091.408.090.998								
PCM Frontblende, Bedienblende Klimaanlage in Wunschfarbe	PCM fron panel, control panel A/C in custom color		●	●	●	●	●	●	●	●
Interior Optikpaket VI bestehend aus:	Interior Styling Package VI consisting of:	091.448.020.998	●	●	●	●	●	●	●	●
für Seriensitze Plus lackiert, Sitzrückenschalen und alle Blenden und Schalter in Wunschfarbe	for serial seats plus painted, seatback shells and all panels and switches in custom color		●	●	●	●	●	●	●	●
Interior Optikpaket VII bestehend aus:	Interior Styling Package VII consisting of:	091.448.030.998 091.421.130.009G 091.421.130.009M 091.421.130.CCC	●	●	●	●	●	●	●	●
für Seriensitze und Sportsitz Plus lackiert, alle Blenden und Schalter in Wunschfarbe Kohlefaser, graphitgrau Kohlefaser, matt graphitgrau Kohlefaser, Individualfarbe	for serial seats and sport seats plus painted, all panels and switches in custom color carbon fiber, graphite grey carbon fiber, matt finish, graphite grey carbon fiber, custom color		●	●	●	●	●	●	●	●



Sitzrückenschalen in Wagenfarbe lackiert.
Seat backpanels painted in body color.



Two-tone painted plastic parts in white and red, letterings at steering wheel and gear selector in red.
Zweifarbige lackierte Kunststoffteile in rot und weiß, Beschriftungen an Lenkrad und Wählhebel in rot.



Nehmen Sie sich die Freiheit, Ihr Interieur bis ins Detail selbst zu kreieren. Wir helfen Ihnen dabei.



Take your freedom to create your very own interior design. We are happy to assist you.

Lederausstattung I | Leather Interior I

■ 991/I bis Modelljahr 2016	■ 991/I up to MY 2016
□ 991/II ab Modelljahr 2017	□ 991/II as of MY 2017
● beide 991 Generationen	● both 991 generations

TECHART Lederausstattung I	TECHART Leather Interior I	
für Cabriolet für Coupé in Individualfarbe Armaturenbrett Ober- und Unterteil, Mittelkonsole inkl. Mittelarmlehne, Schalthebel, Türverkleidungen vorn und im Fond, Türzuziehgriffe, Kartentaschenklappen Sitze vorn/ hinten, A-B-C-Säule 3-Teilig, Sonnenblenden	für Cabriolet for Coupé in custom color Dashboard upper and lower segment, center console including armrest, gear lever, door panels at front and rear, door handles, door pocket covers front and rear seats, A-B-C- pillars, Sun visors	091.407.010.000 091.407.020.000

911 Carrera / Carrera Cabriolet	911 Carrera S / Carrera S Cabriolet	911 Carrera 4 / Carrera 4 Cabriolet	911 Carrera 4S / Carrera 4S Cabriolet	911 Targa 4 / Targa 4S	911 GTS / 4 GTS / Targa 4 GTS	911 GT3 / GT3 RS	911 Turbo / Turbo Cabriolet	911 Turbo S / Turbo S Cabriolet
●	●	●	●	●	●	●	●	●
●	●	●	●	●	●	●	●	●



Exklusiv-Lederausstattung | Exquisite Leather Interior

■ 991/I bis Modelljahr 2016	■ 991/I up to MY 2016
□ 991/II ab Modelljahr 2017	□ 991/II as of MY 2017
● beide 991 Generationen	● both 991 generations

TECHART Exklusiv-Lederausstattung	TECHART Exquisite Leather Interior										
für Cabriolet für Coupé	for Cabriolet for Coupé	091.407.015.000	091.407.025.000	●	●	●	●	●	●	●	●
Ausstattungsumfang: Armaturenbrettober-/unterteile, Mittelkonsoleneinheit, Wählhebelgriff, Türverkleidungen vorn/hinten, Türgriffe, Kartentaschenklappen, Blenden, Sitze vorn / hinten inkl. Verblendungen, Säulenverkleidungen, Dachhimmel, Sonnenblenden,	Features: Dashboard upper and lower segment, center console, armrest, shift knob handle door panels at front and rear, door handles and panels, door pockets front and rear seats including seat basis, pillar trims, roof lining, sun visors,			●	●	●	●	●	●	●	●

911 Carrera / Carrera Cabriolet	911 Carrera S / Carrera S Cabriolet	911 Carrera 4 / Carrera 4 Cabriolet	911 Carrera 4S / Carrera 4S Cabriolet	911 Targa 4 / Targa 4S	911 GTS / 4 GTS / Targa 4 GTS	911 GT3 / GT3 RS	911 Turbo / Turbo Cabriolet	911 Turbo S / Turbo S Cabriolet
---------------------------------	-------------------------------------	-------------------------------------	---------------------------------------	------------------------	-------------------------------	------------------	-----------------------------	---------------------------------









Technologische Herausforderung: die einheitliche Farbwiedergabe auch bei Individualfarben – ob Leder, Alcantara®, Lack, Garn, Kunststoff oder Licht.



High-tech challenge: a homogeneous color saturation of leather, Alcantara®, paint, yarn, plastic and light. Even if the color is a customized tone.







TECHART Automobildesign GmbH
Röntgenstraße 47, 71229 Leonberg, Germany

Tel. +49 (0)7152 9339-0, Fax +49 (0)7152 9339-33, E-Mail info@techart.de, <http://www.techart.de>

Änderungen und Irrtümer vorbehalten. Gedruckt in der Bundesrepublik Deutschland.
Subject to change without prior notice. Printed in Germany.

091.991.119.8109-03, 11/2017

Copyright by TECHART Automobildesign GmbH